

# LARGA

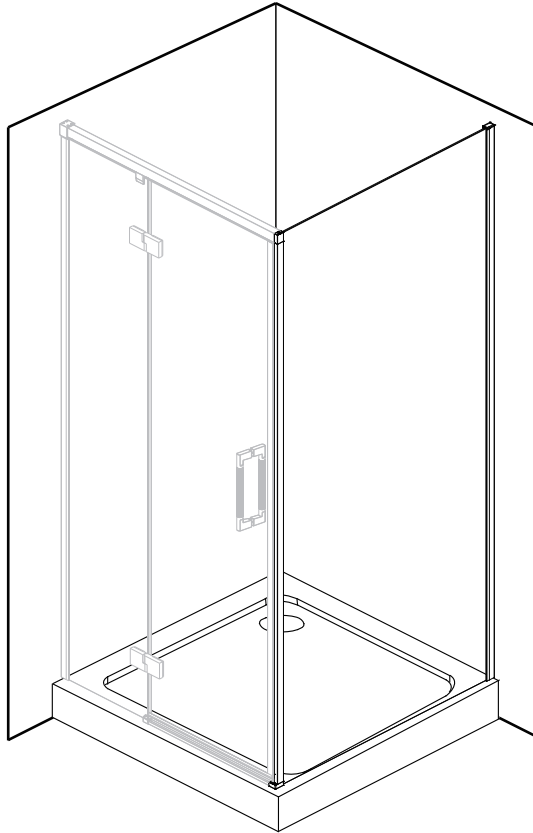

PL INSTRUKCJA MONTAŻU I EKSPLOATACJI

CZ NÁVOD NA MONTÁŽ A ÚDRŽBU

SK NÁVOD NA MONTÁŽ A ÚDRŽBU

EST PAIGALDUS- JA KASUTUSJUHEND

LT MONTAVIMO IR EKSPLOATAVIMO INSTRUKCIJA

LV MONTĀŽAS UN EKSPLUATĀCIJAS INSTRUKCIJA

DE MONTAGE- UND AUFBAUANLEITUNG

RO INSTRUCȚIUNI DE MONTAJ ȘI OPERARE

HU SZERELÉSI ÉS ÜZEMELTETÉSI ÚTMUTATÓ

UA ІНСТРУКЦІЯ З МОНТАЖУ І ЕКСПЛУАТАЦІЇ

BY ІНСТРУКЦЫЯ ПА МАНТАЖЫ І ЭКСПЛУАТАЦЫІ

RU ИНСТРУКЦИЯ ПО МОНТАЖУ И ЭКСПЛУАТАЦИИ

EN INSTRUCTIONS FOR ASSEMBLY AND USE

FR INSTALLATION ET UTILISATION - MODE

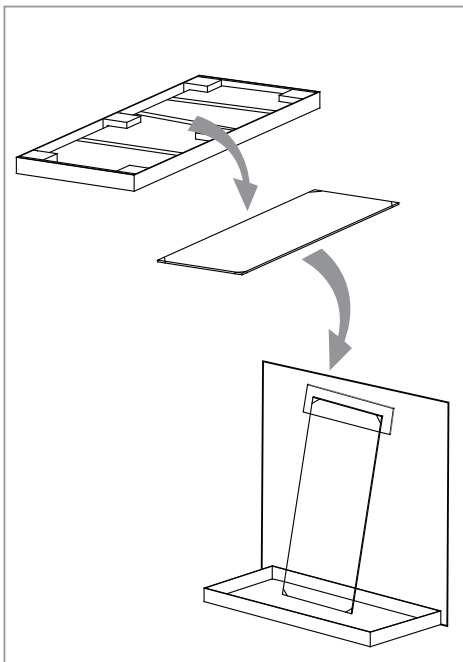
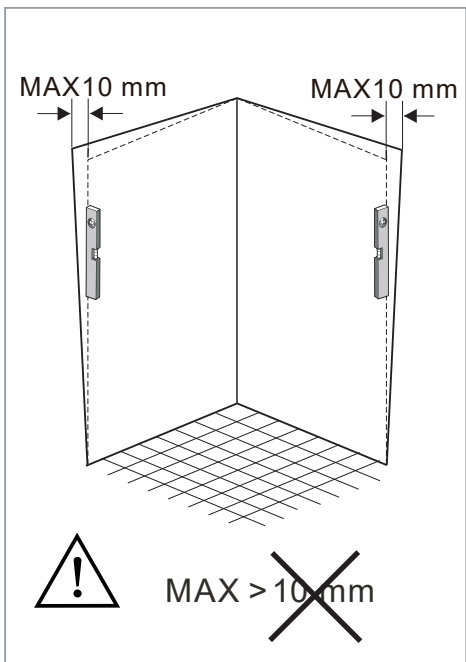
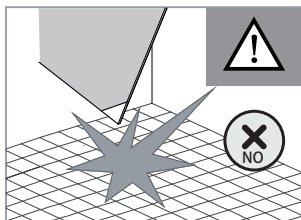
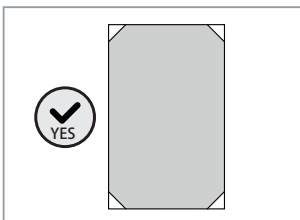
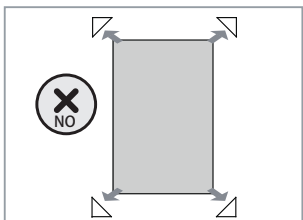
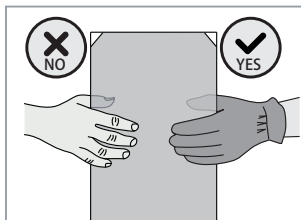
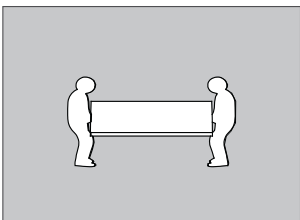
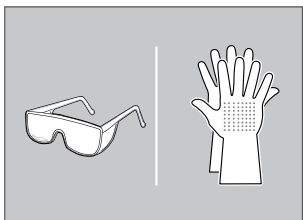
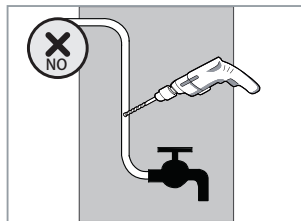
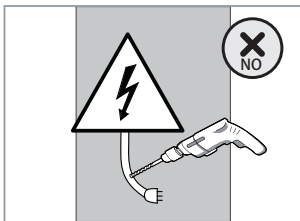
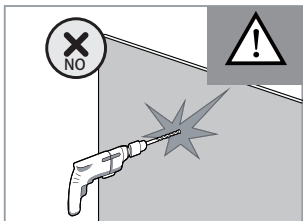

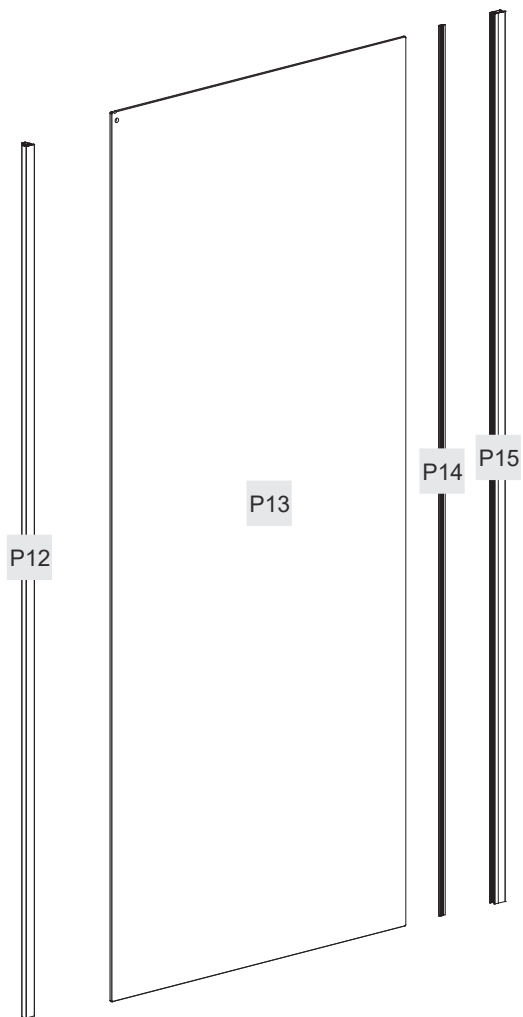
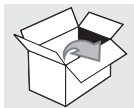

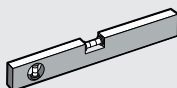
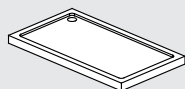
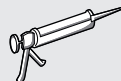
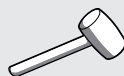
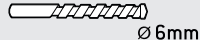
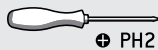
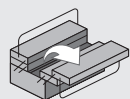
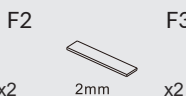
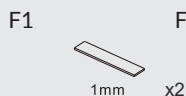
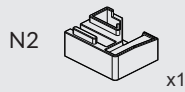
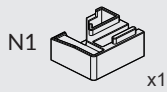
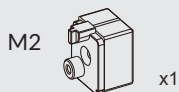
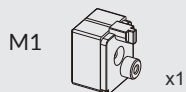
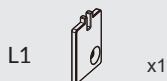
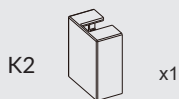
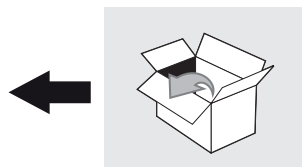
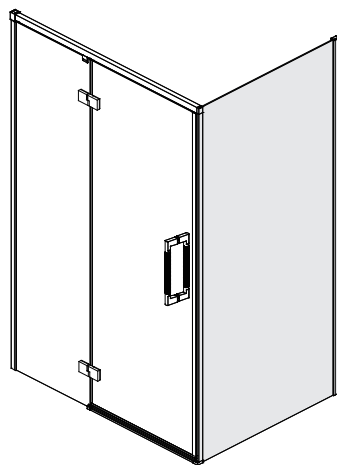

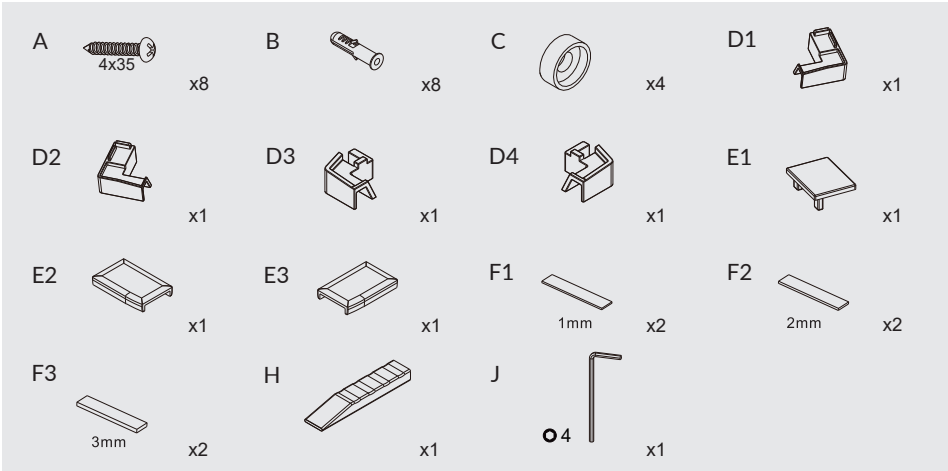
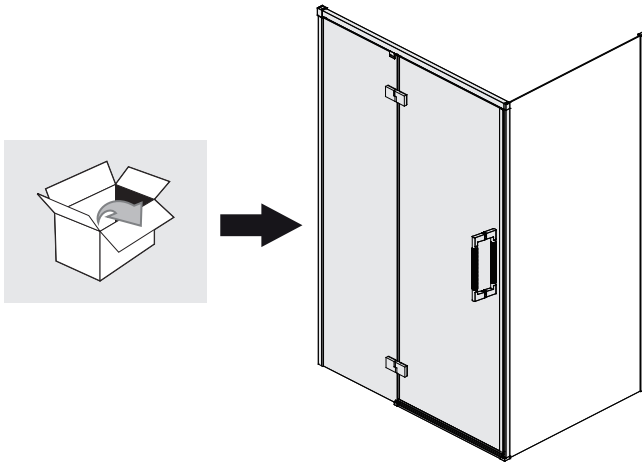

1.

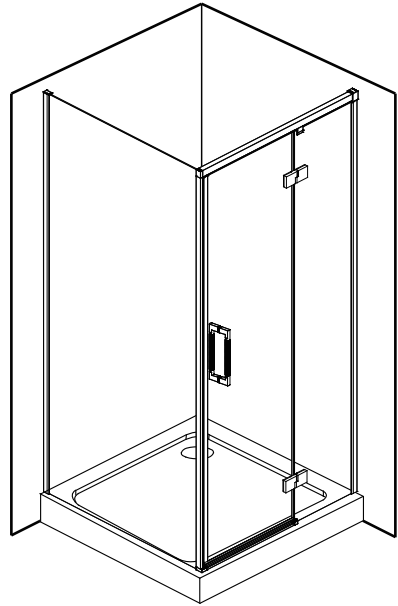
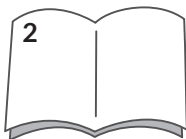
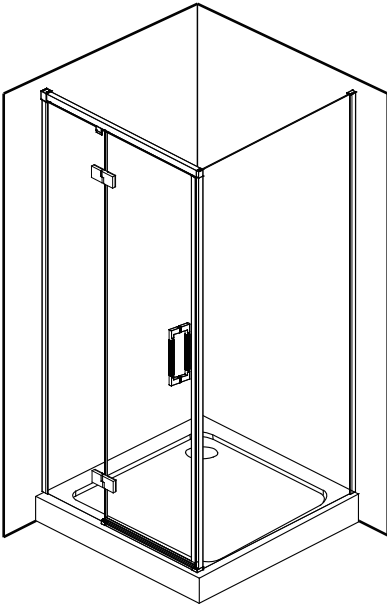

## 2.

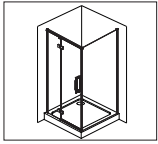

SIZE	X(mm)	Y (mm)
800X800X1950	783	795
800X900X1950	783	895
800X1000X1950	783	995
800X1200X2000	783	1195
900X800X1950	883	795
900X900X1950	883	895
900X1000X1950	883	995
900X1200X2000	883	1195

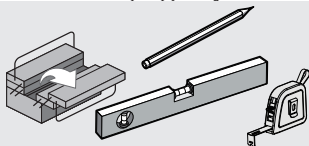
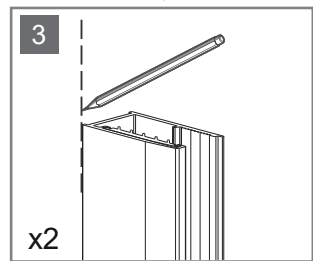
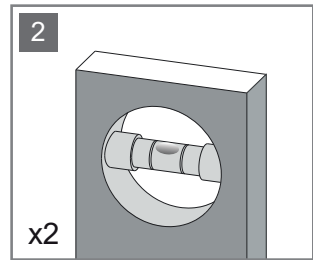
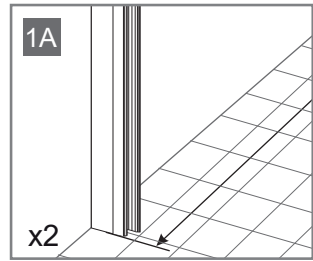
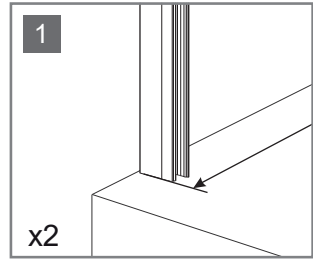
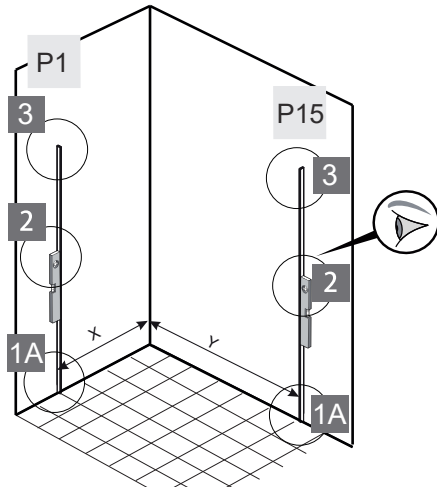
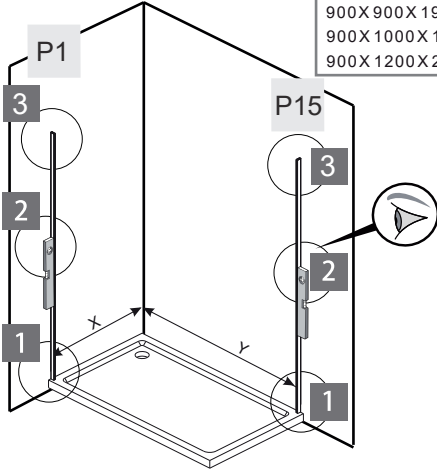

P1  x1

P15  x1



3.

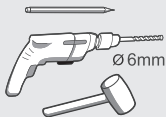
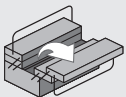
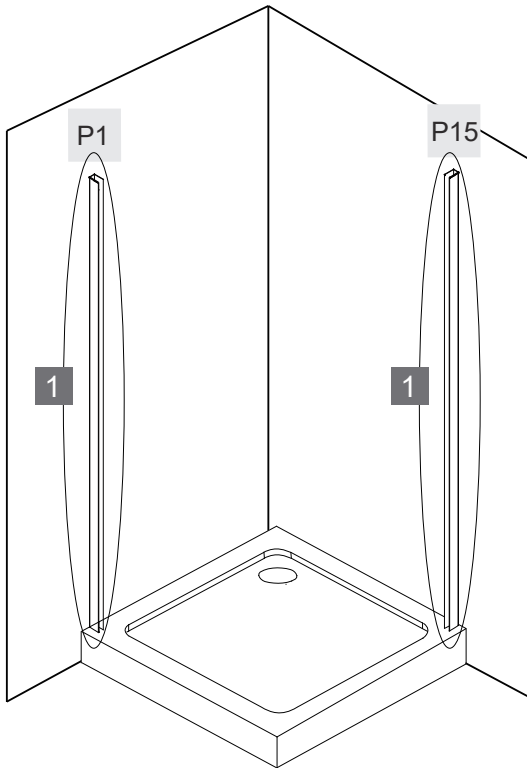
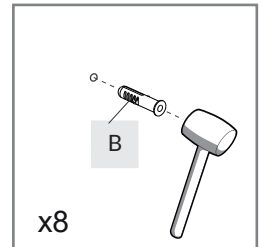
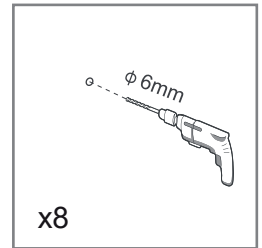
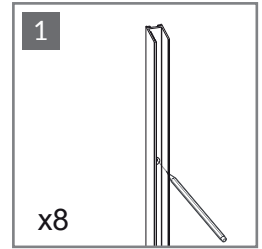
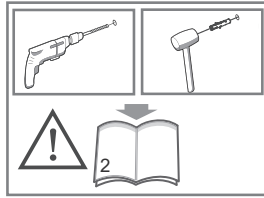
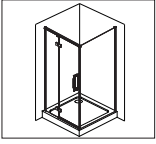

B



x8





4.

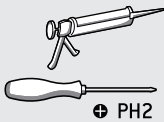
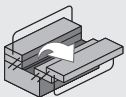
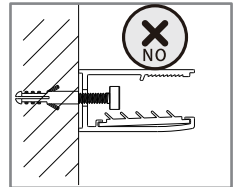
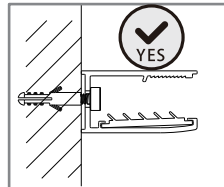
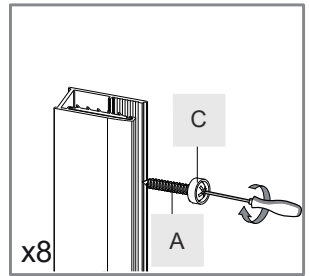
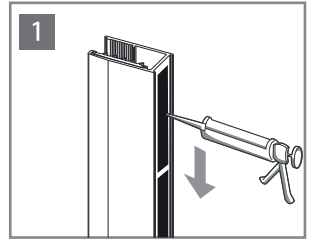
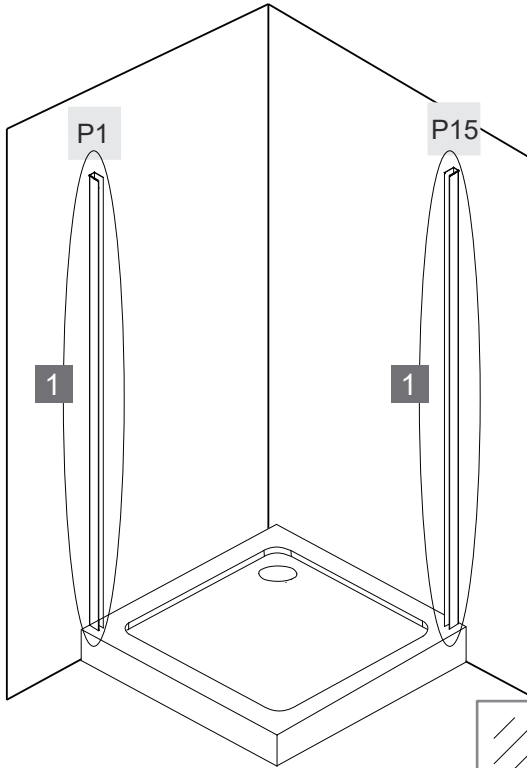
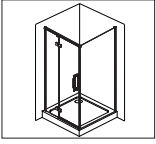

PH2

A



4x35

x8

C



x8



# 5.

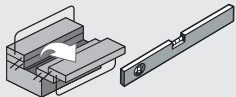
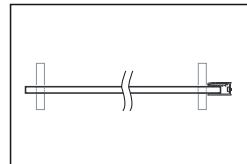
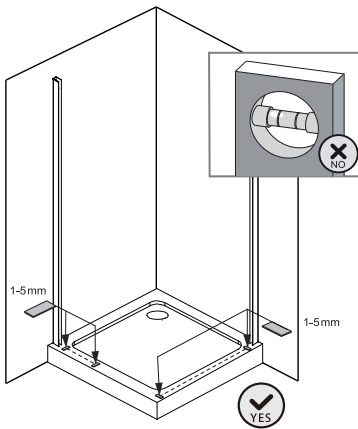
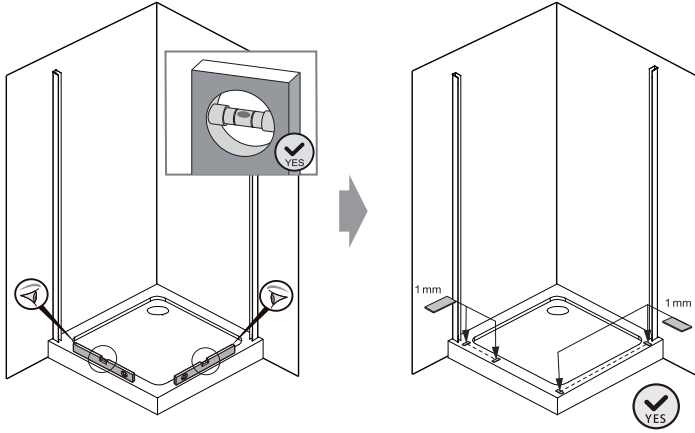
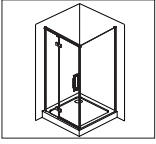

F1



x4

F2



x4

F3



x4



# 6.

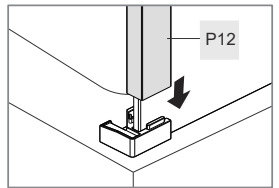
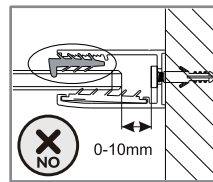
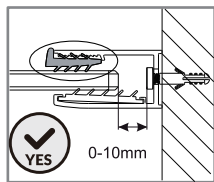
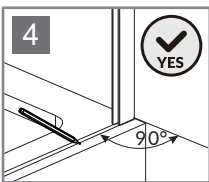
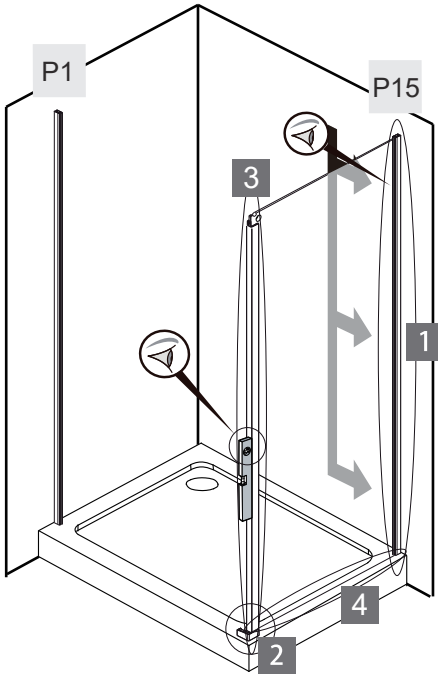
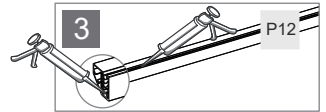
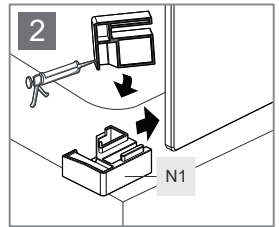
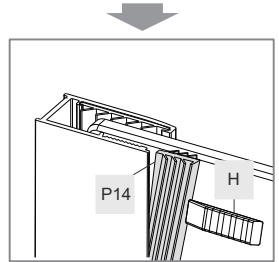
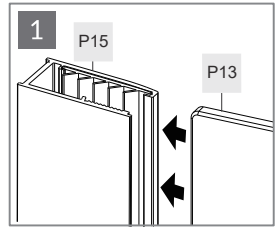
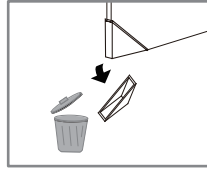
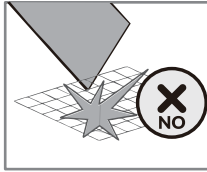
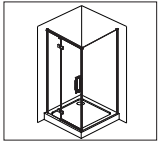

# 7.

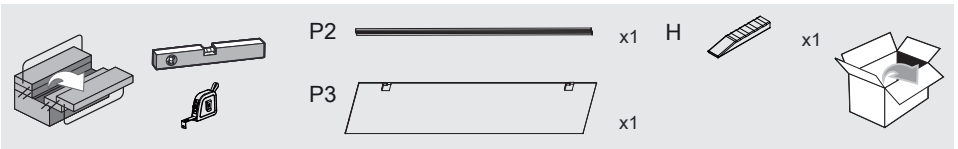
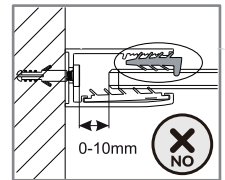
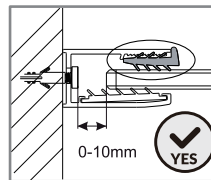
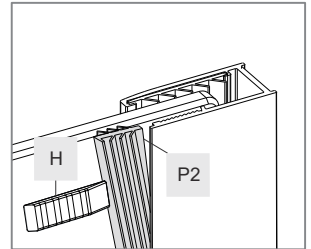
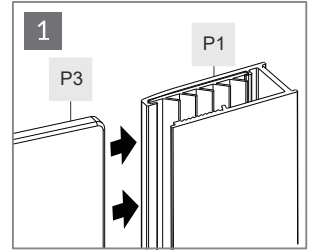
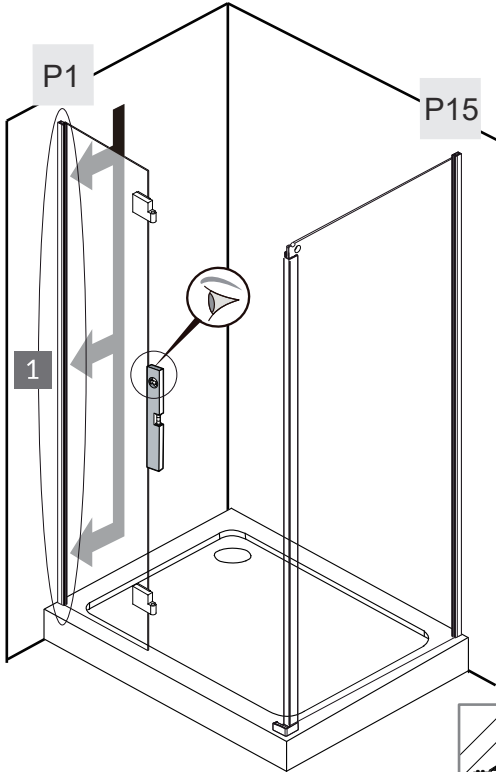
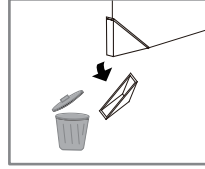
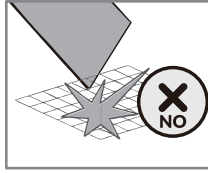
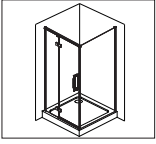

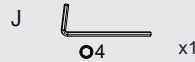
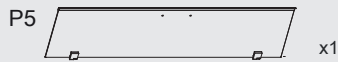
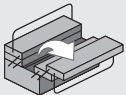
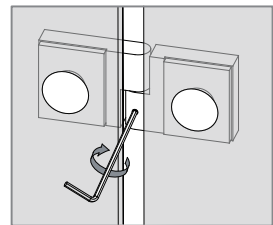
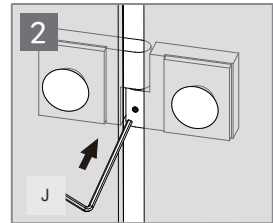
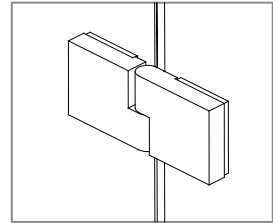
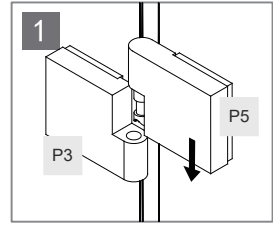
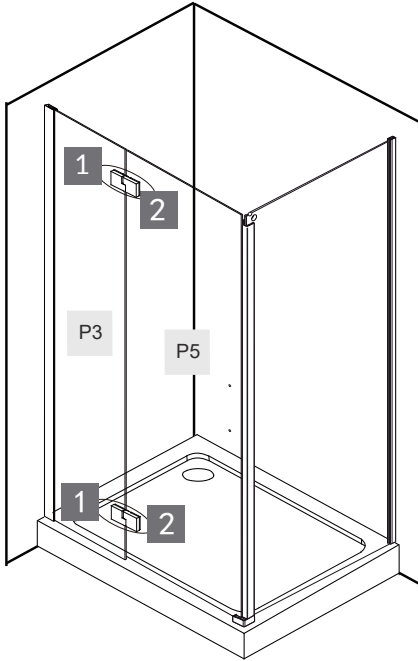
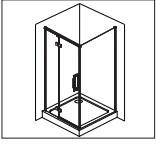

8.

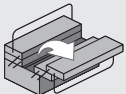
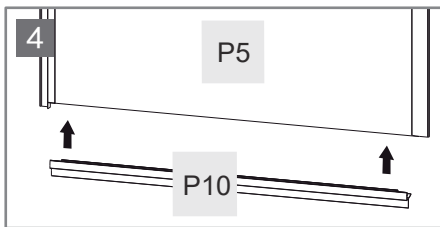
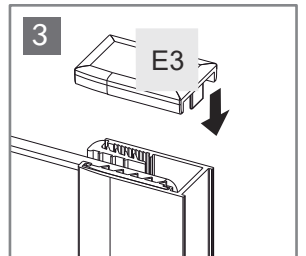
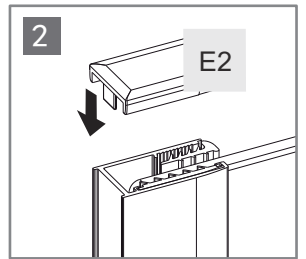
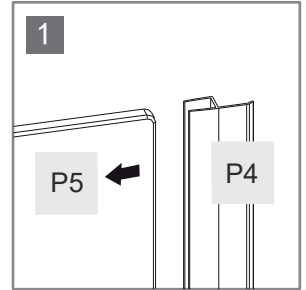
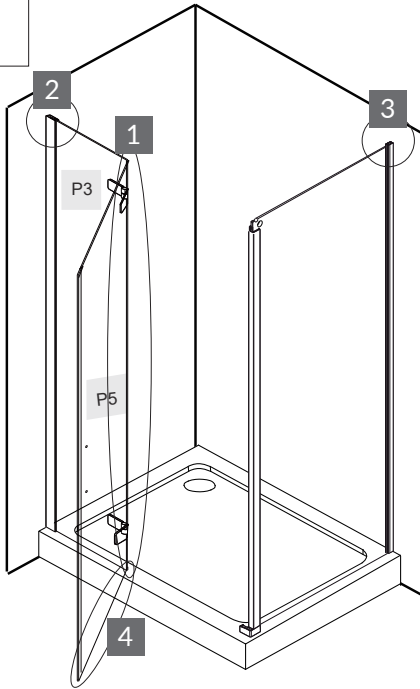
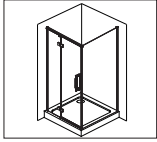

9.



P4  x1  
P10  x1

E2  x1  
E3  x1



10.

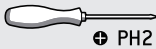
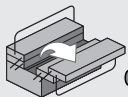
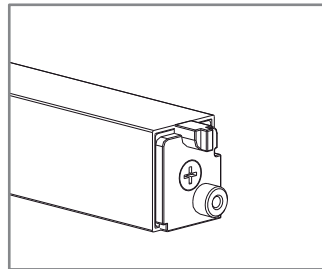
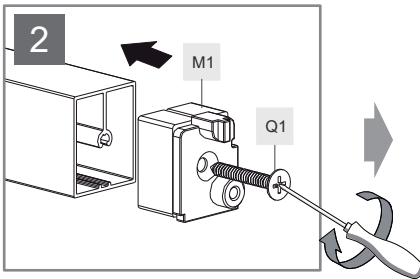
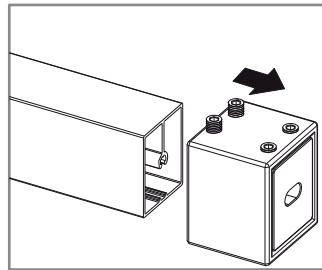
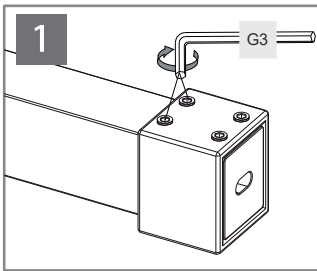
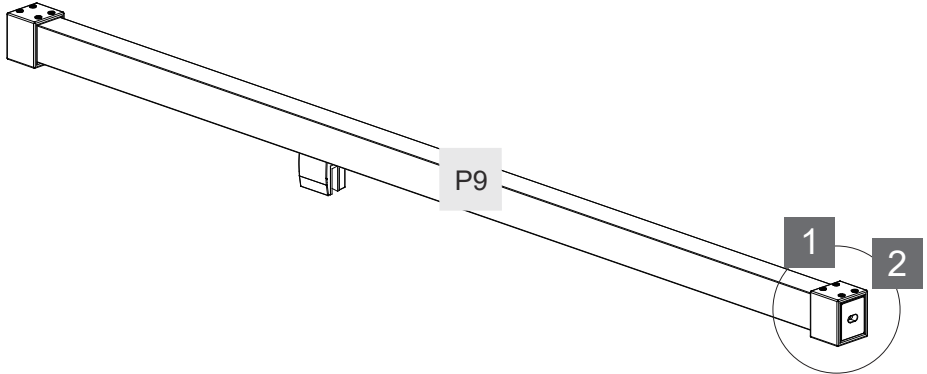
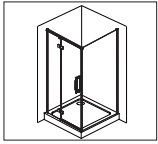

P9



x1

Q1

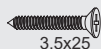

x1

G3

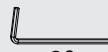

x1

M1



x1



11.

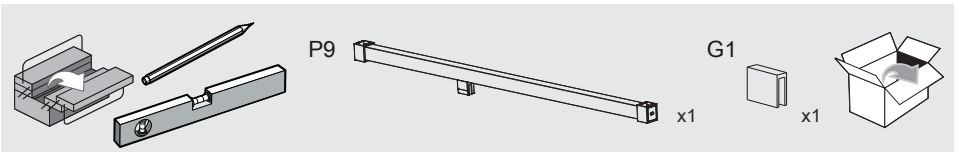
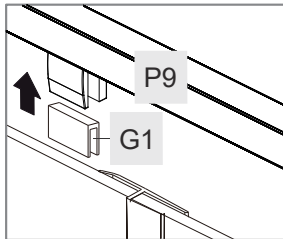
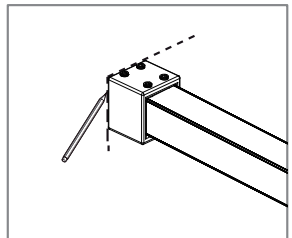
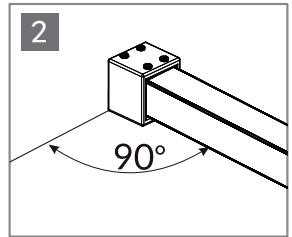
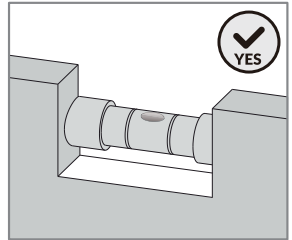
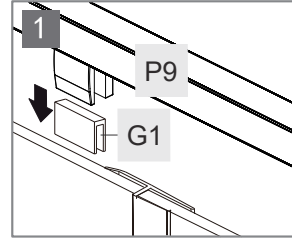
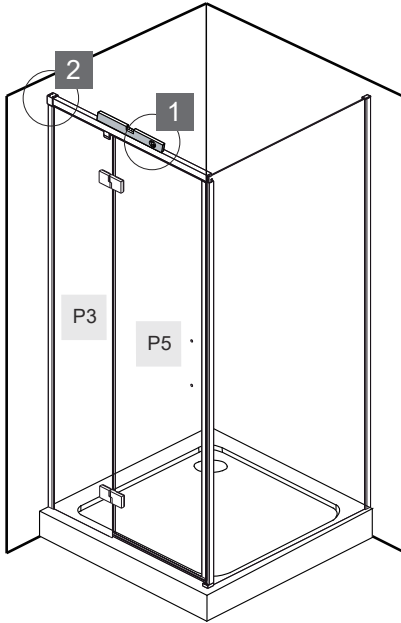
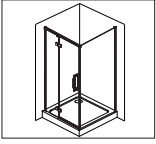



# 12.

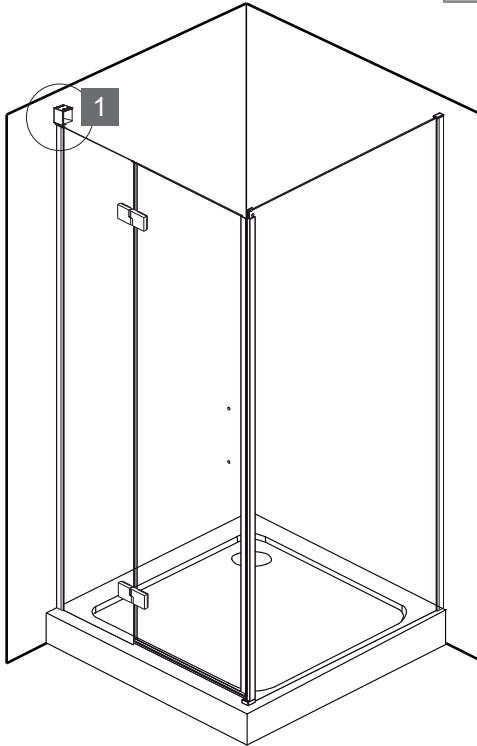
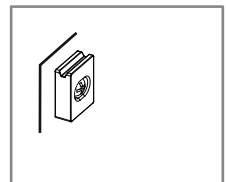
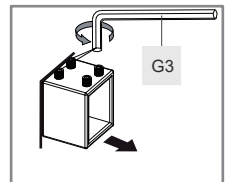
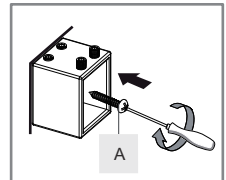
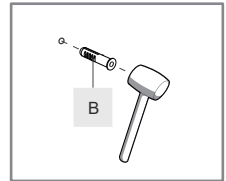
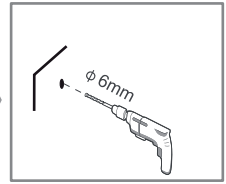
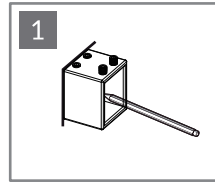
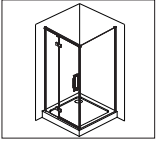

		PH2		A		x1	
				B		x1	
		Ø 6mm		G3		x1	

13.

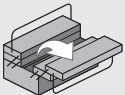
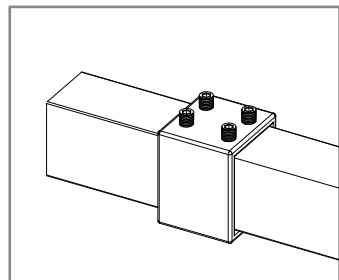
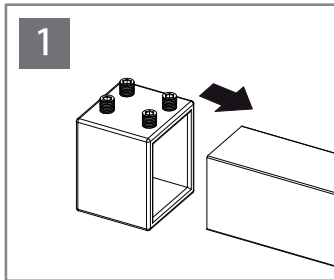
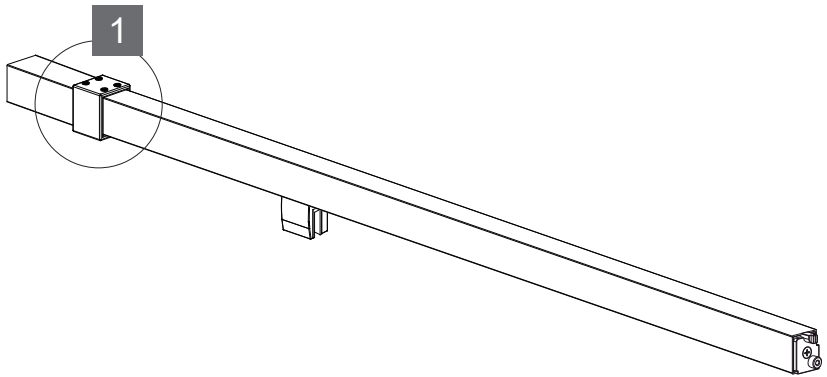
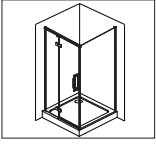

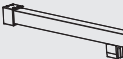
P9  x1



14.

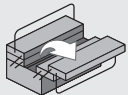
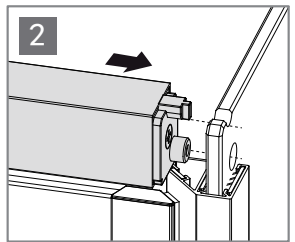
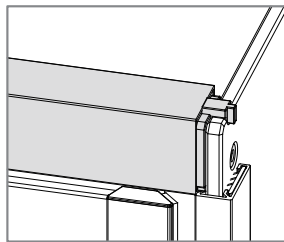
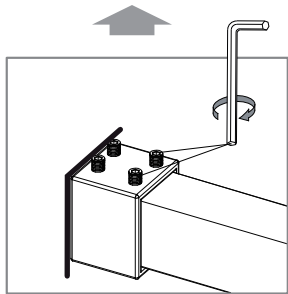
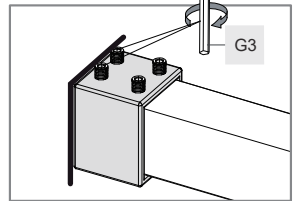
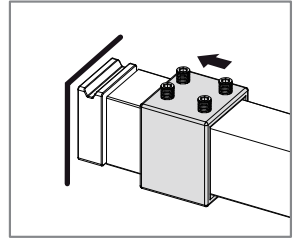
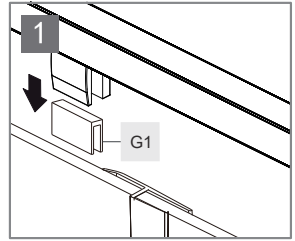
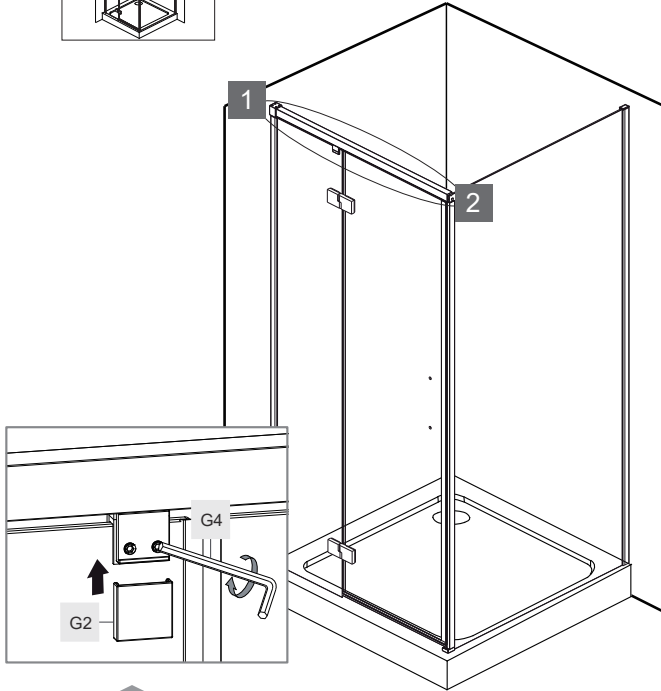
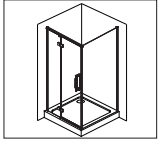

G1



x1

G2



x1

G3



x1

G4



x1



15.

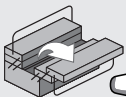
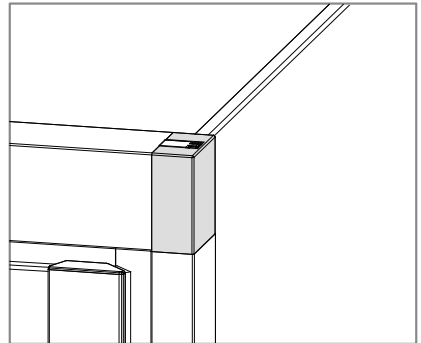
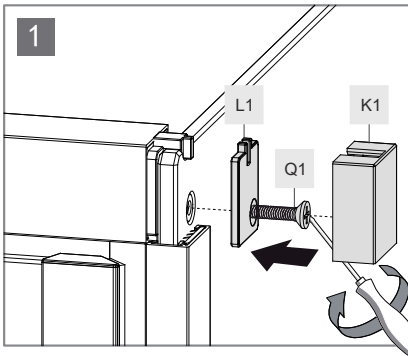
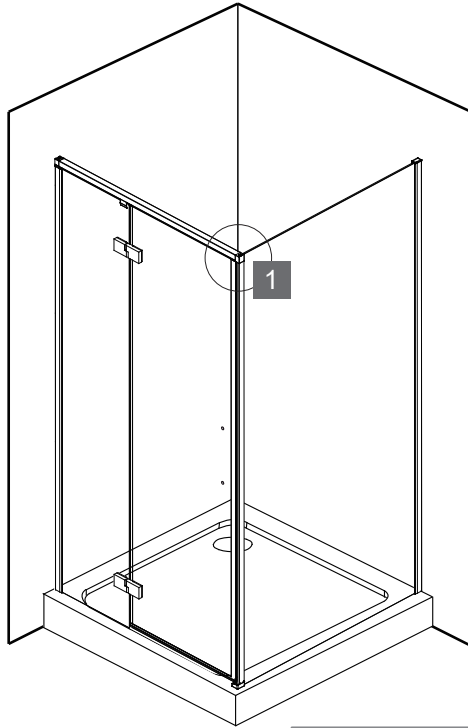
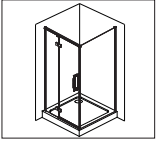

L1



x1

Q1



3.5x25

x1

K1



x1



PH2

16.

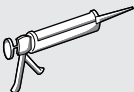
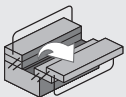
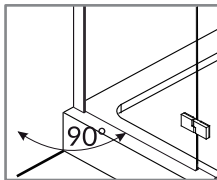
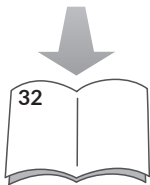
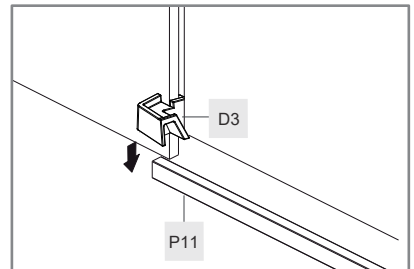
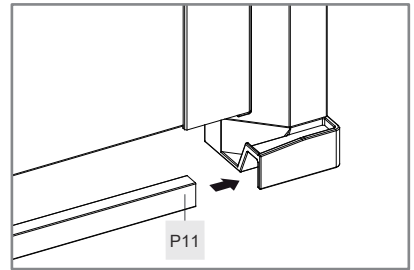
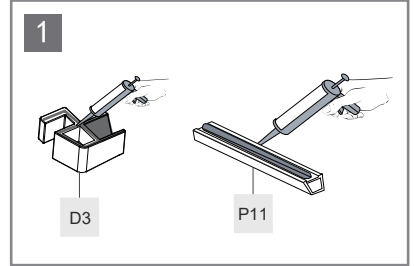
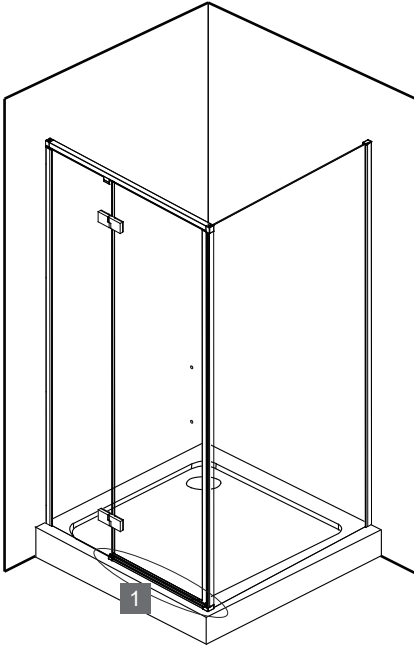
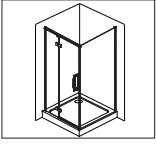

D3  x1

P11  x1



# 17.

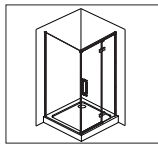

SIZE	X(mm)	Y (mm)
800X800X1950	783	795
800X900X1950	783	895
800X1000X1950	783	995
800X1200X2000	783	1195
900X800X1950	883	795
900X900X1950	883	895
900X1000X1950	883	995
900X1200X2000	883	1195

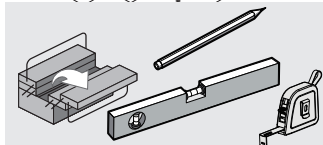
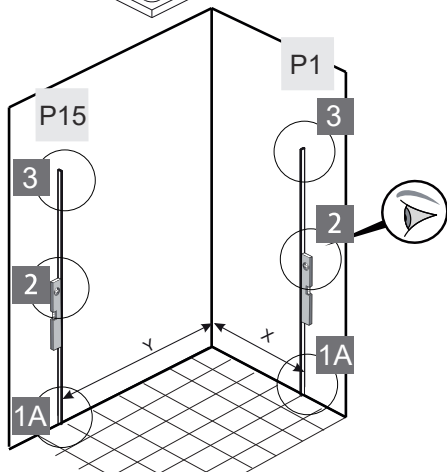
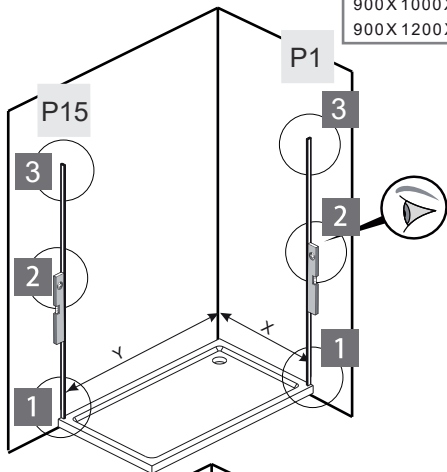
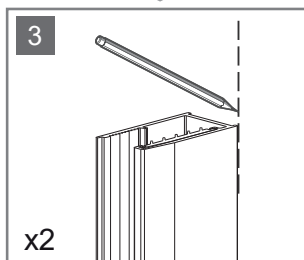
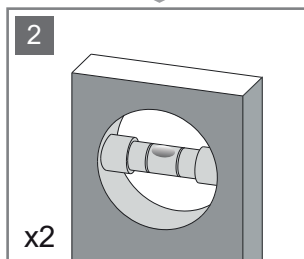
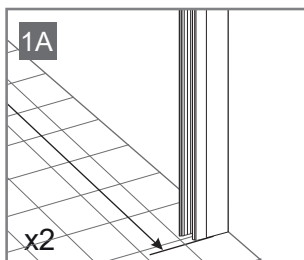
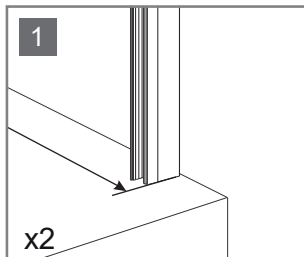

P1  x1

P15  x1



18.

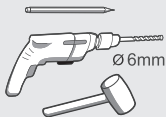
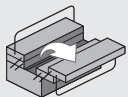
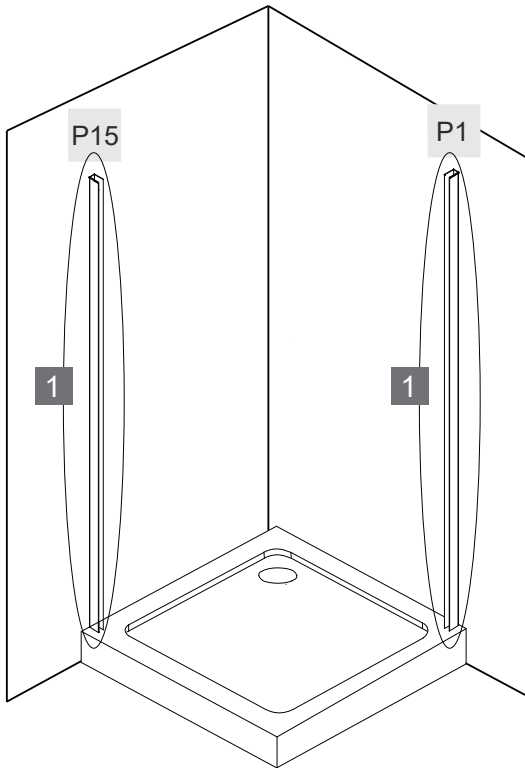
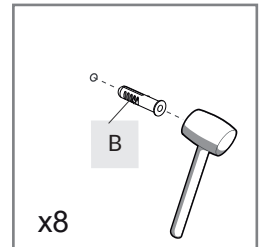
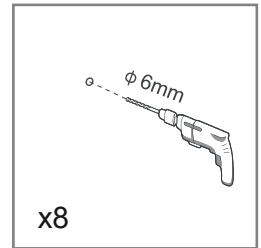
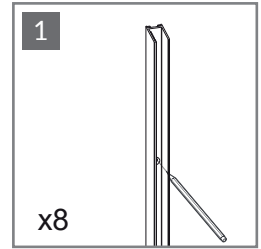
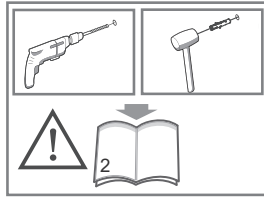
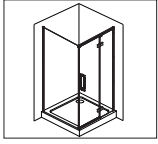

B



x8



19.

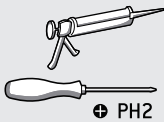
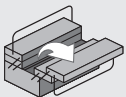
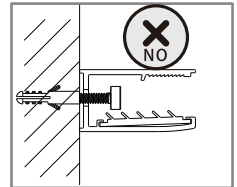
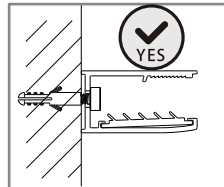
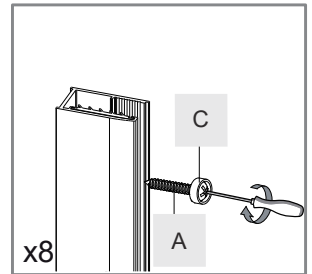
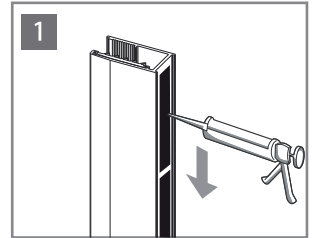
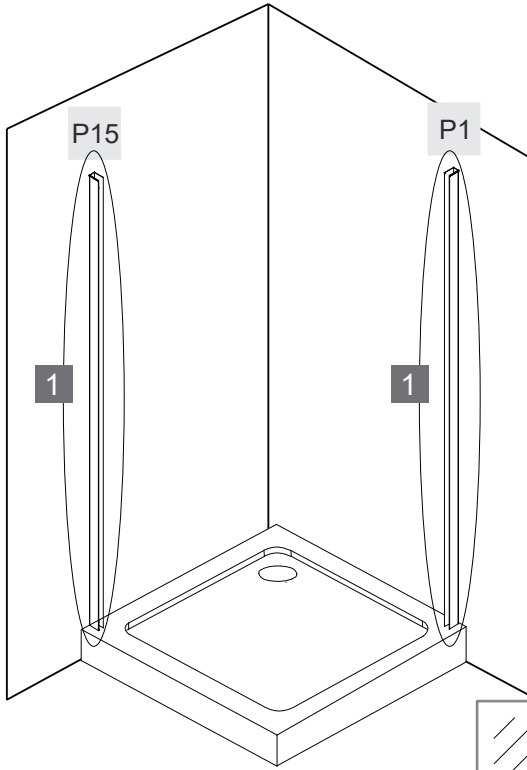
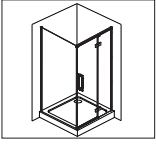

A



x8

C



x8





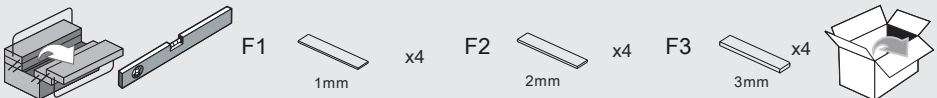
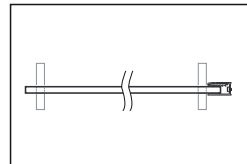
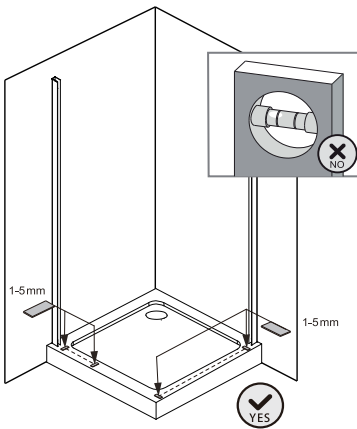
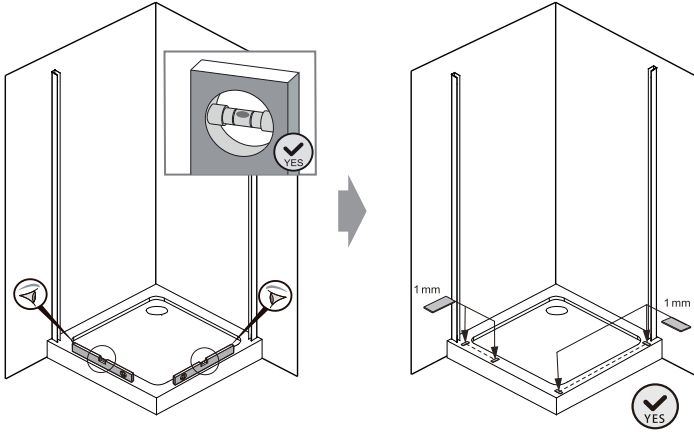
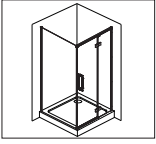

# 21.

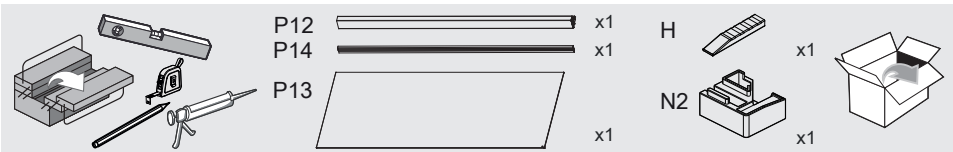
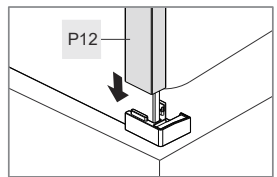
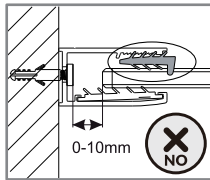
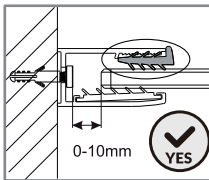
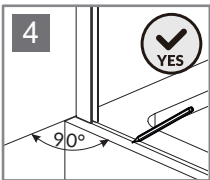
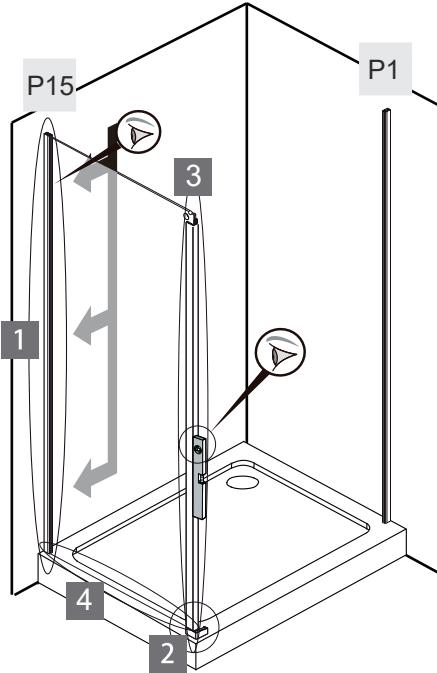
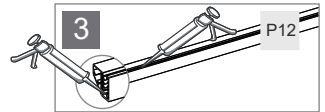
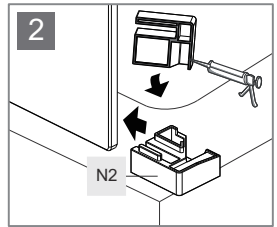
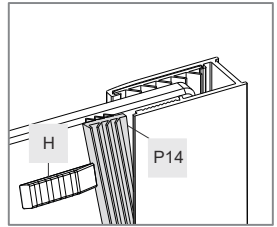
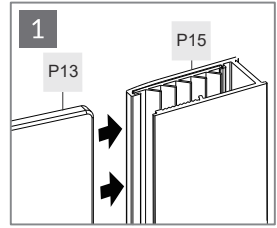
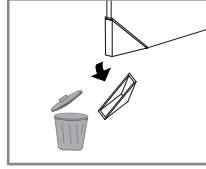
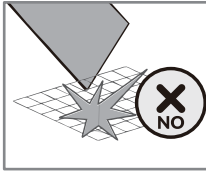
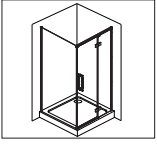

22.

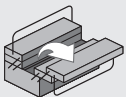
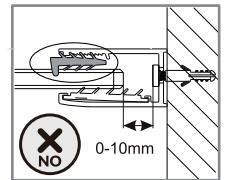
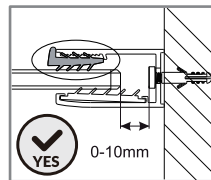
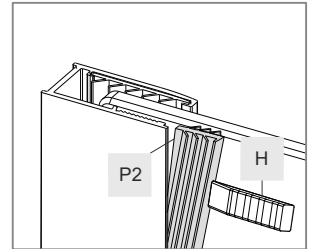
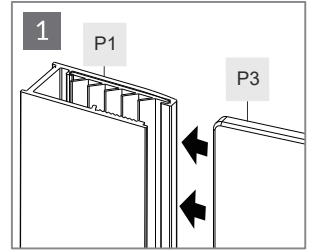
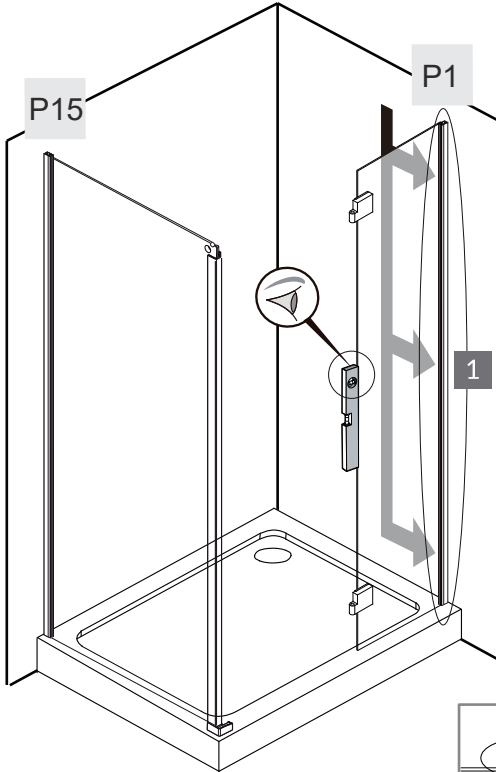
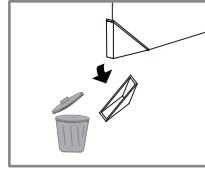
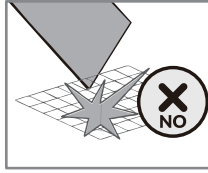
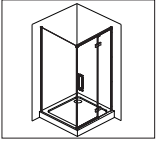

P2 ————— x1 H



x1

P3 ————— x1



23.

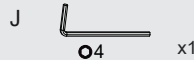
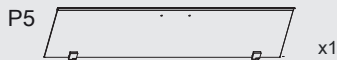
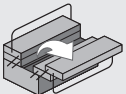
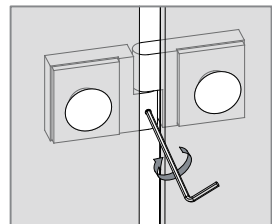
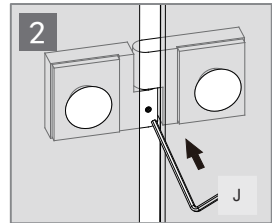
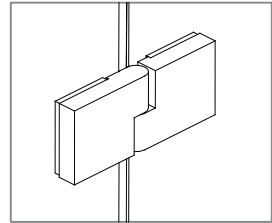
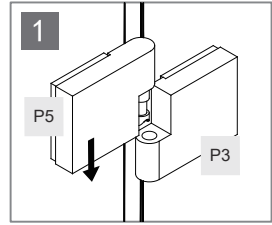
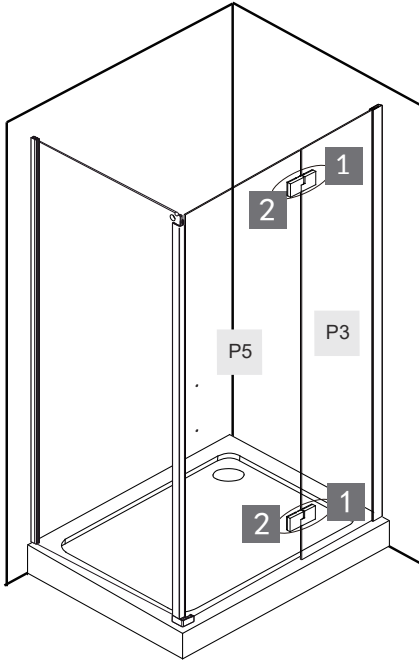
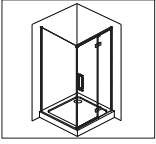

24.

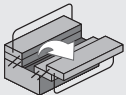
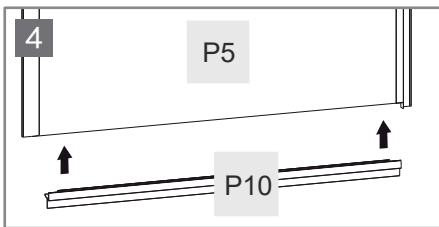
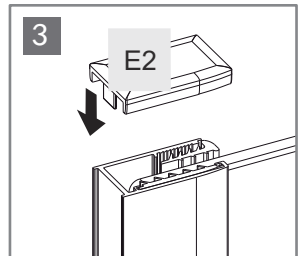
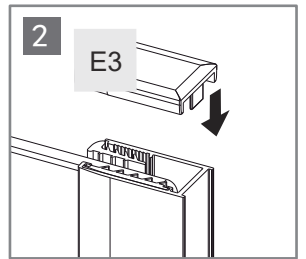
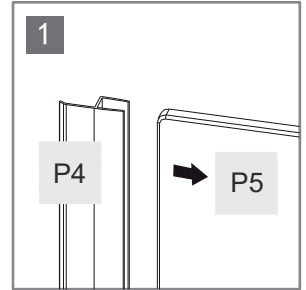
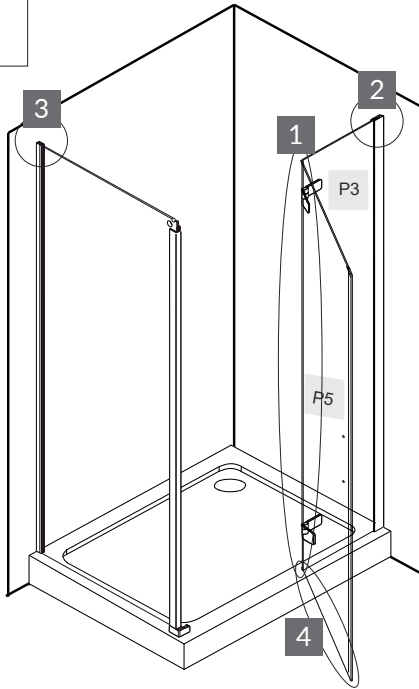
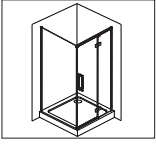

P4  x1

P10  x1

E2  x1

E3  x1



25.

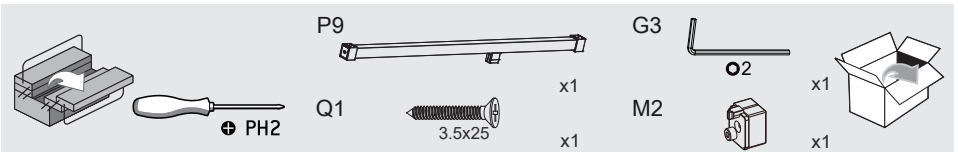
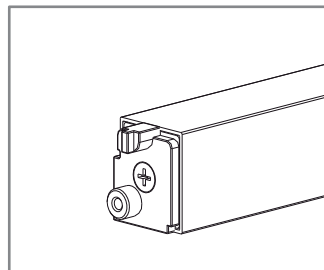
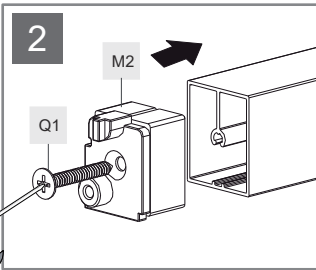
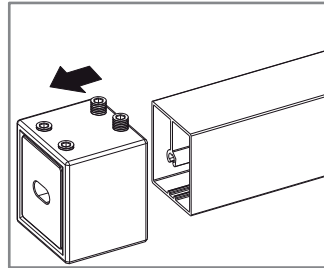
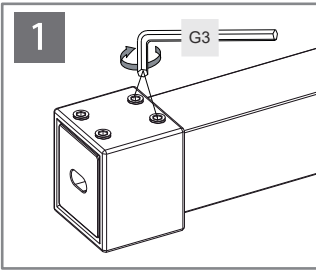
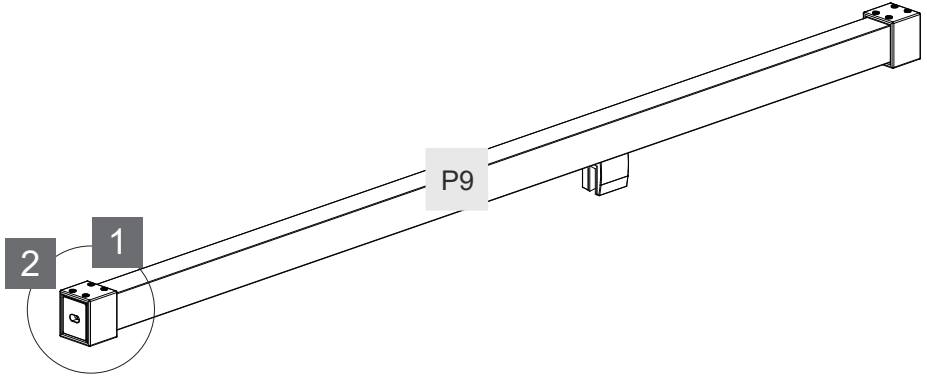
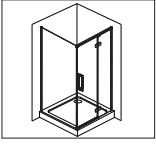

26.

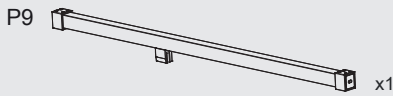
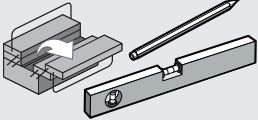
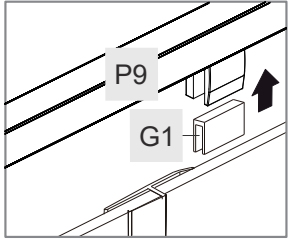
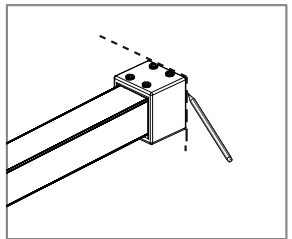
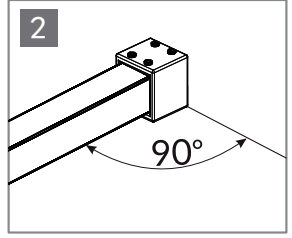
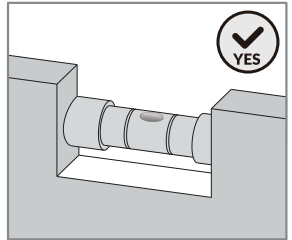
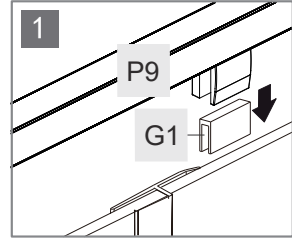
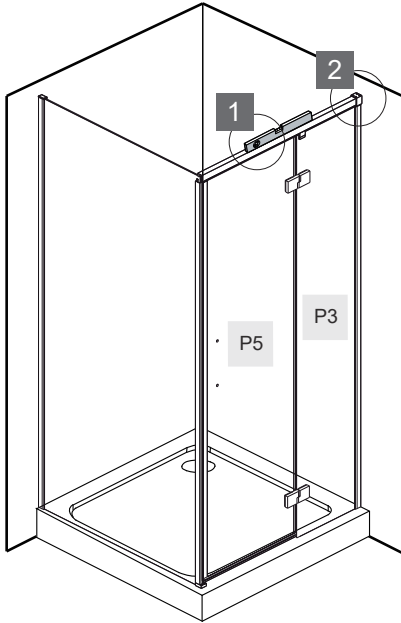
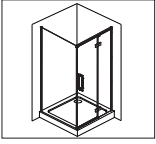

27.

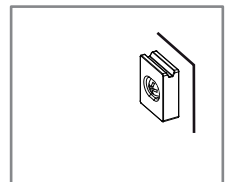
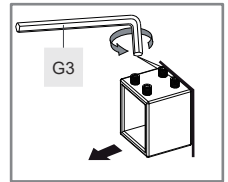
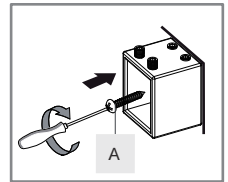
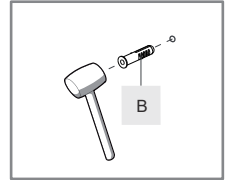
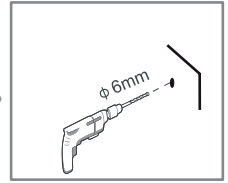
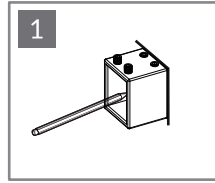
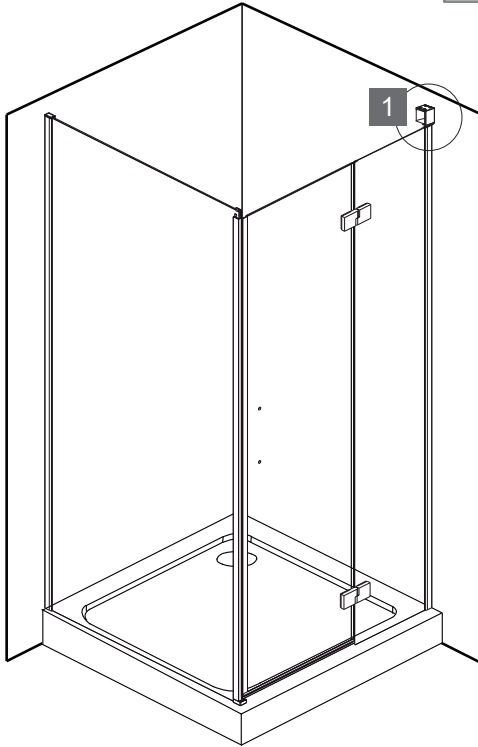
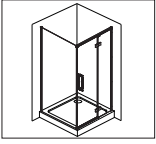

	PH2		x1	
	$\varnothing 6\text{mm}$		x1	
			x1	



28.

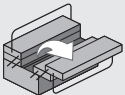
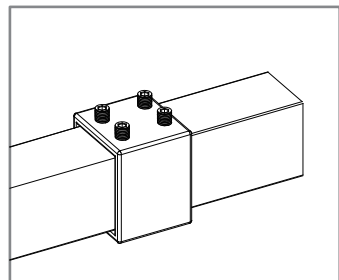
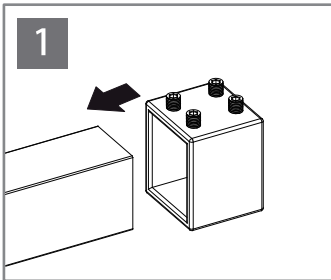
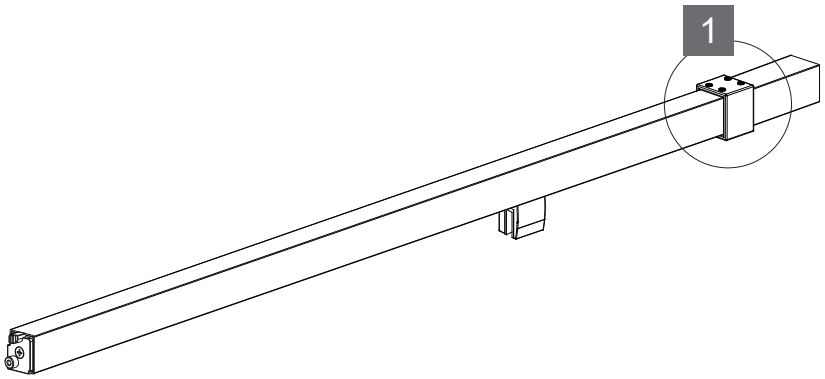
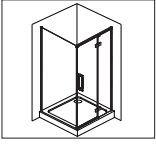

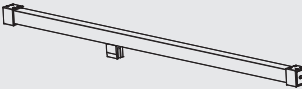
P9  x1



29.

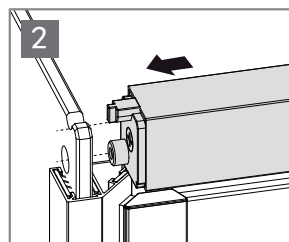
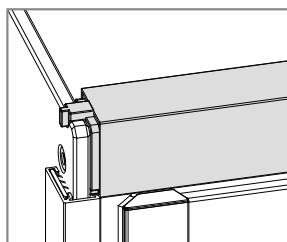
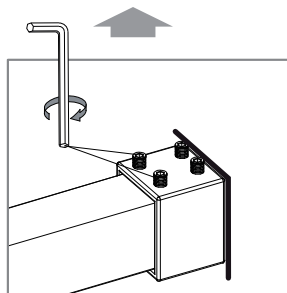
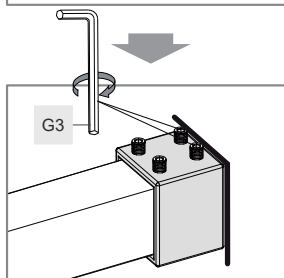
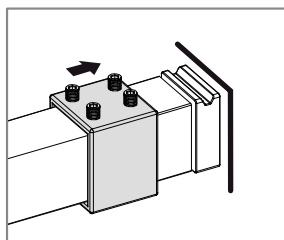
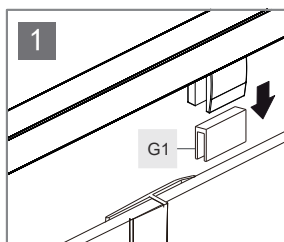
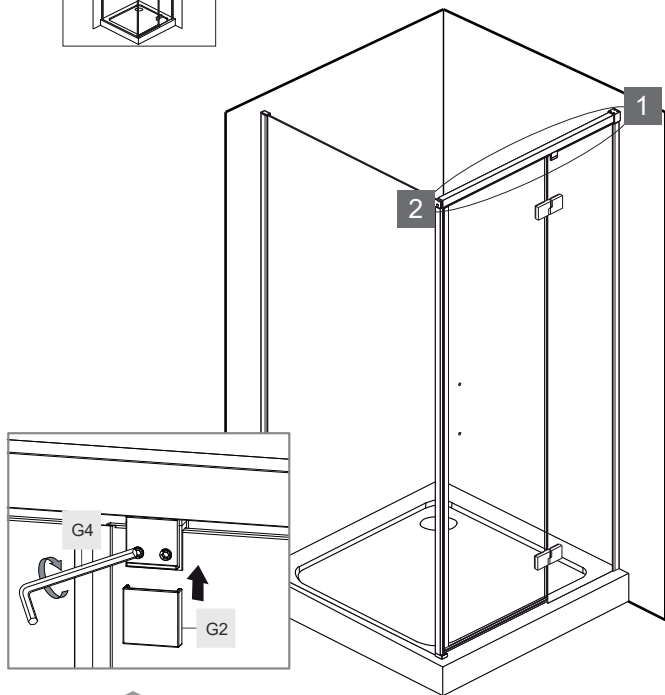
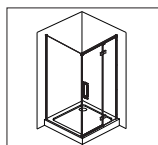

30.

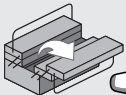
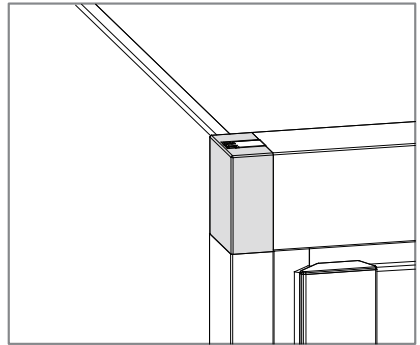
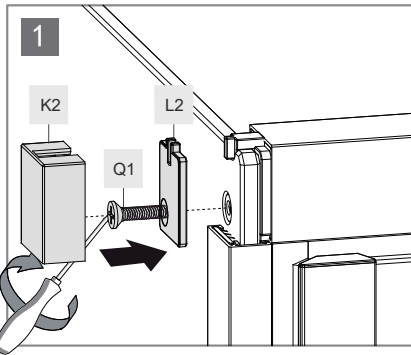
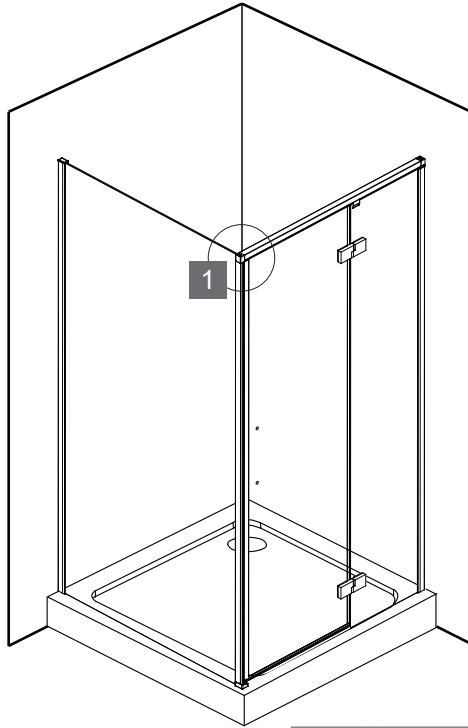
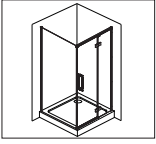

L2



x1

Q1



3.5x25 x1

K2



x1



PH2

31.

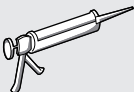
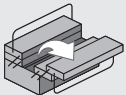
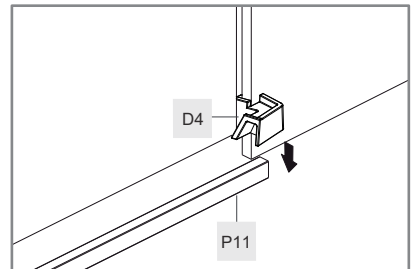
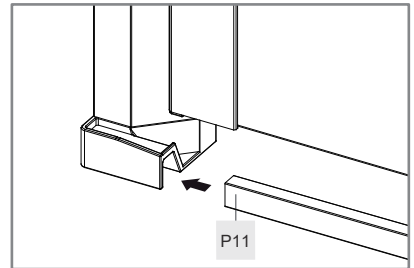
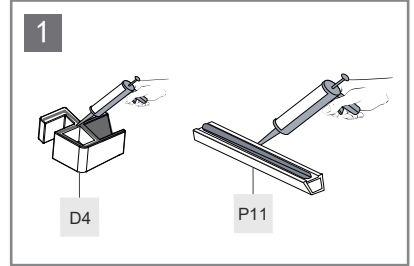
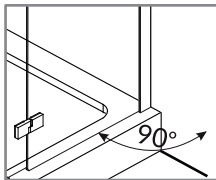
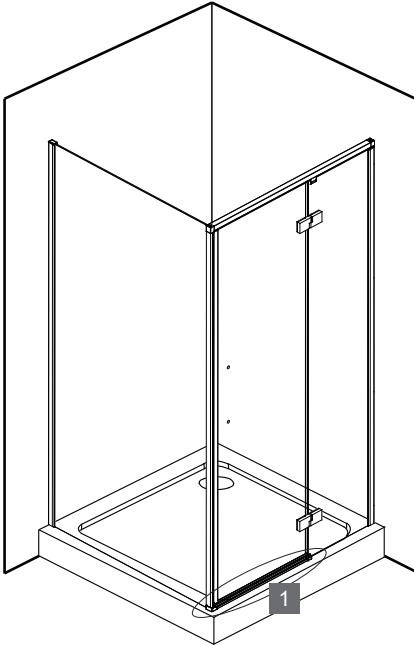
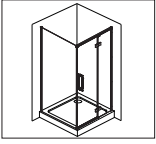

D4  x1

P11  x1



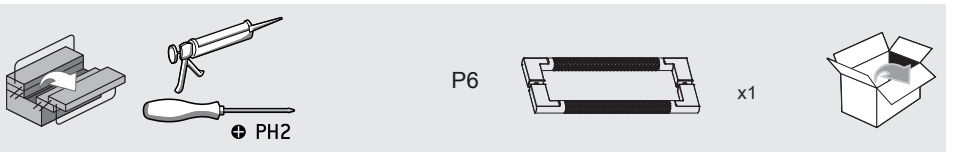
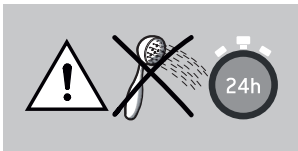
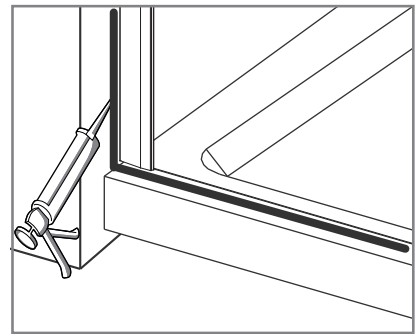
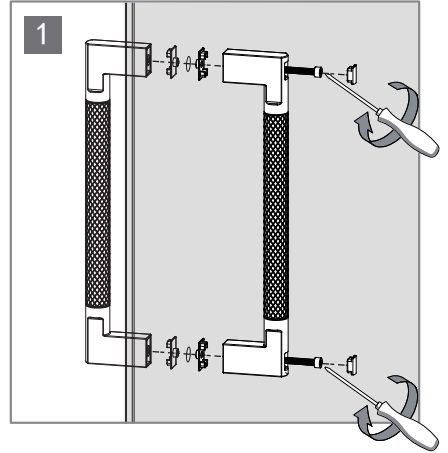
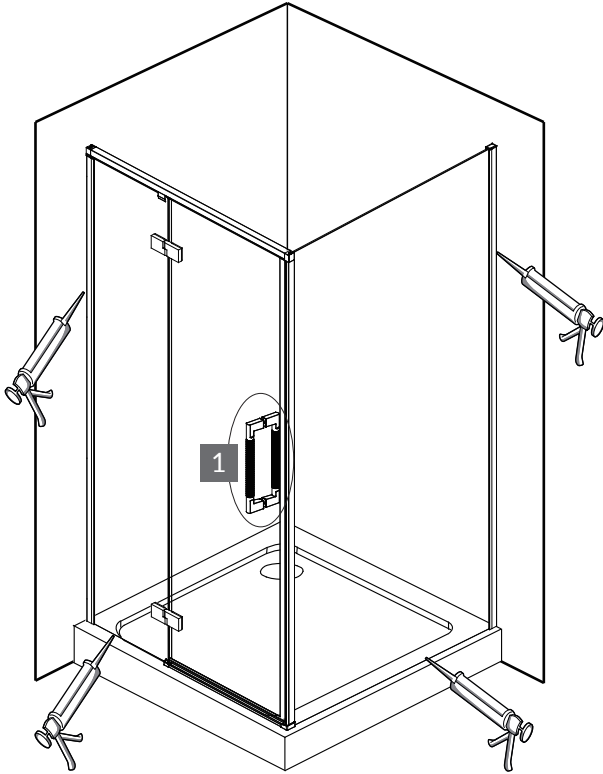





6.5<PH<7.5

