

# CREA

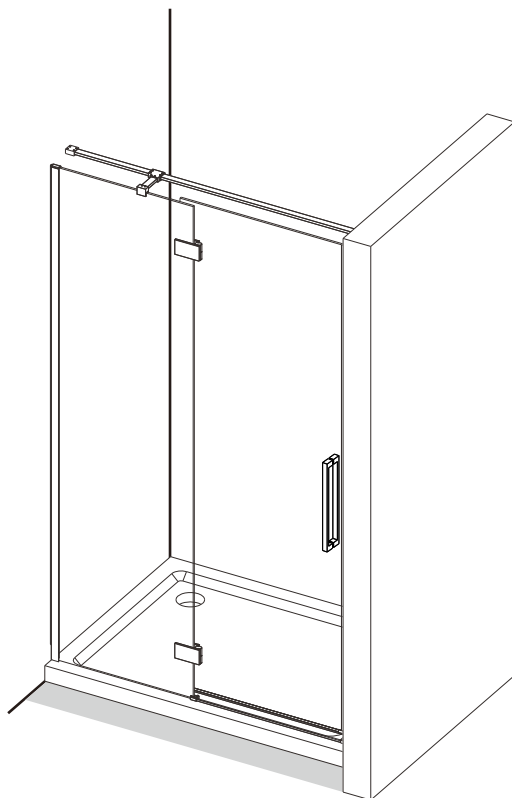

PL INSTRUKCJA MONTAŻU I EKSPLOATACJI

CZ NÁVOD NA MONTÁŽ A ÚDRŽBU

SK NÁVOD NA MONTÁŽ A ÚDRŽBU

EST PAIGALDUS- JA KASUTUSJUHEND

LT MONTAVIMO IR EKSPLOATAVIMO INSTRUKCIJA

LV MONTĀŽAS UN EKSPLUATĀCIJAS INSTRUKCIJA

DE MONTAGE- UND AUFBAUANLEITUNG

RO INSTRUCȚIUNI DE MONTAJ ȘI OPERARE

HU SZERELÉSI ÉS ÜZEMELTETÉSI ÚTMUTATÓ

UA ІНСТРУКЦІЯ З МОНТАЖУ І ЕКСПЛУАТАЦІЇ

BY ІНСТРУКЦЫЯ ПА МАНТАЖЫ І ЭКСПЛУАТАЦЫІ

RU ИНСТРУКЦИЯ ПО МОНТАЖУ И ЭКСПЛУАТАЦИИ

EN INSTRUCTIONS FOR ASSEMBLY AND USE

FR INSTALLATION ET UTILISATION - MODE

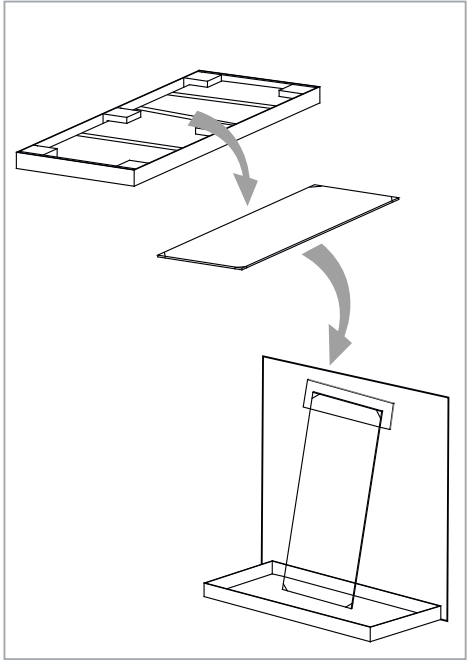
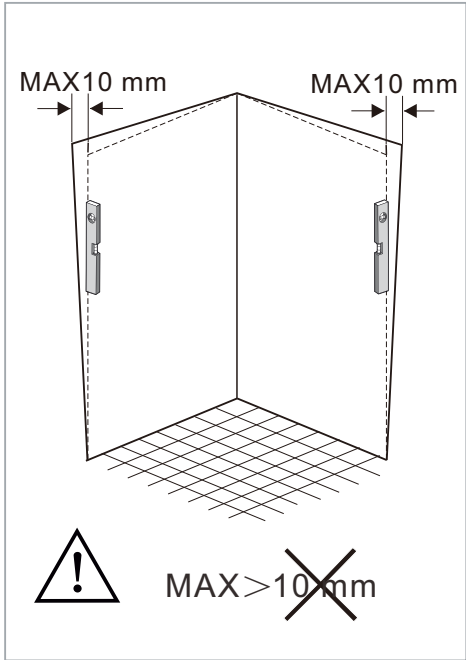
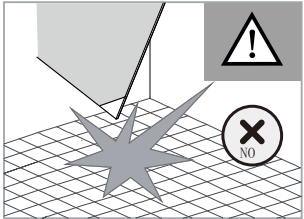
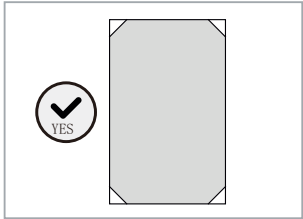
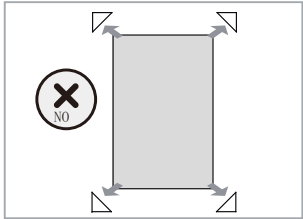
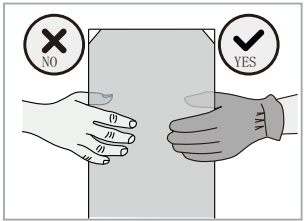
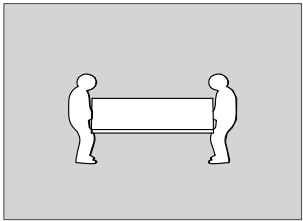
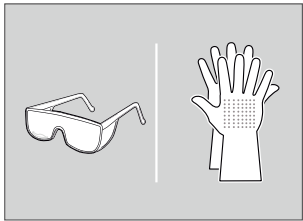
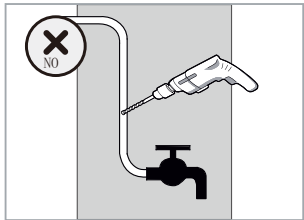
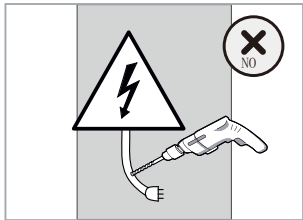
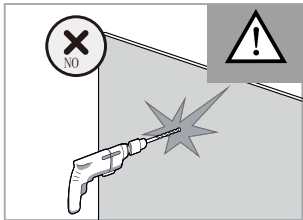

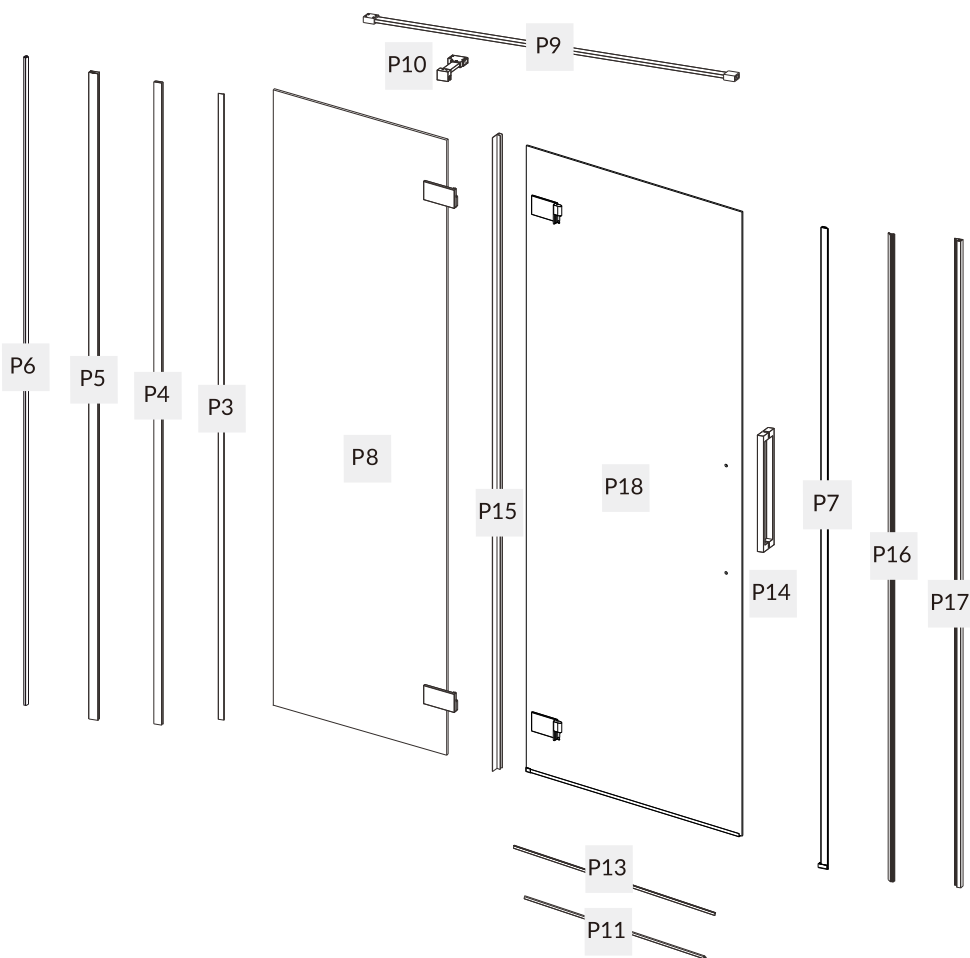

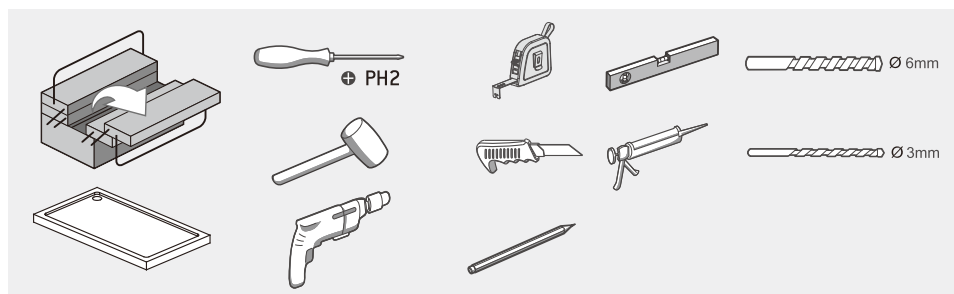
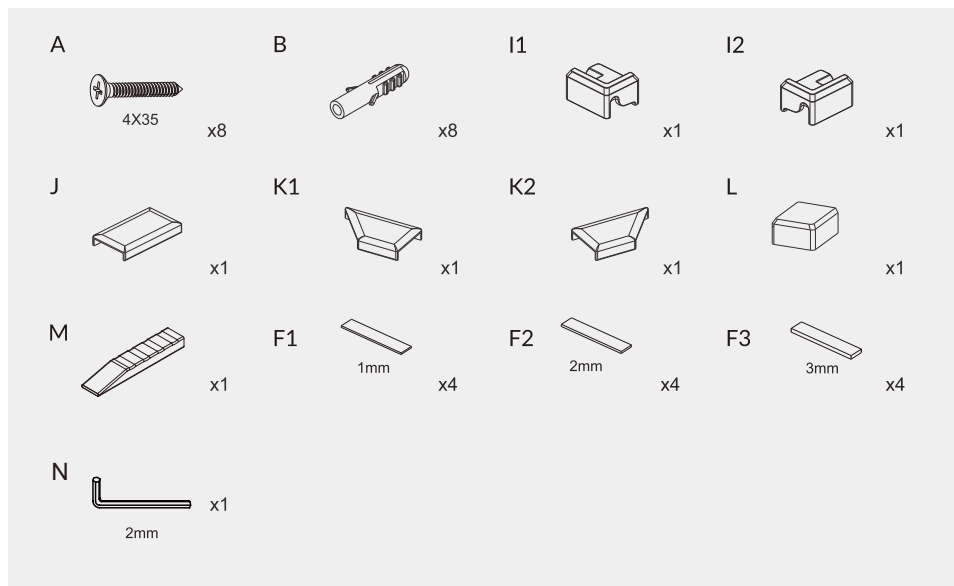

1.

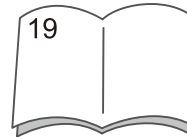
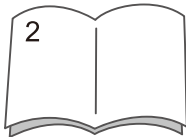
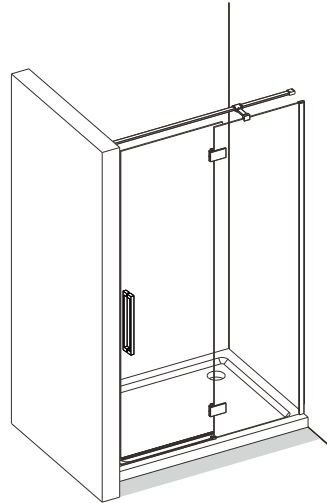
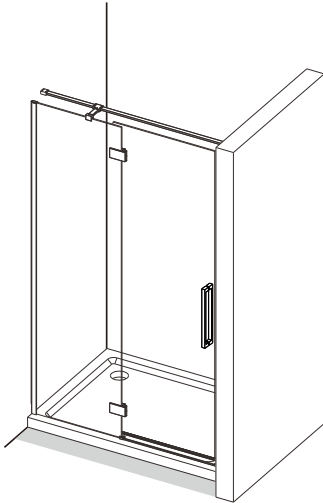

2.

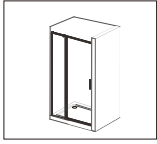

| SIZE        | X(mm)     |
|-------------|-----------|
| 900 × 2000  | 890-900   |
| 1000 × 2000 | 990-1000  |
| 1200 × 2000 | 1190-1200 |

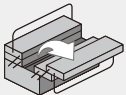
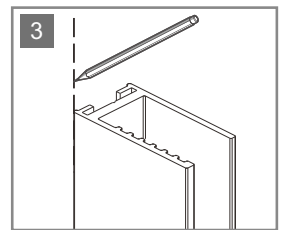
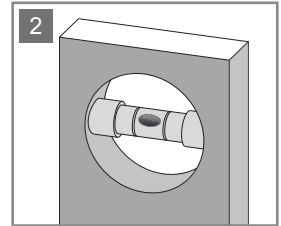
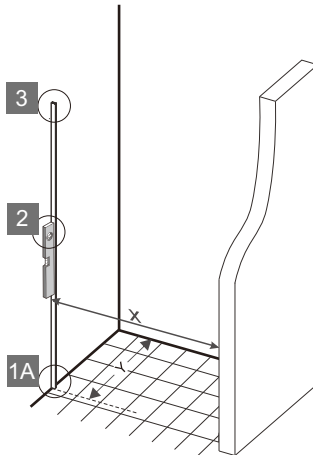
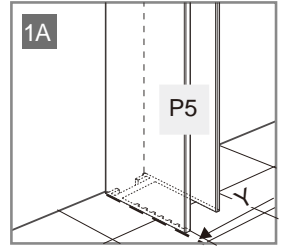
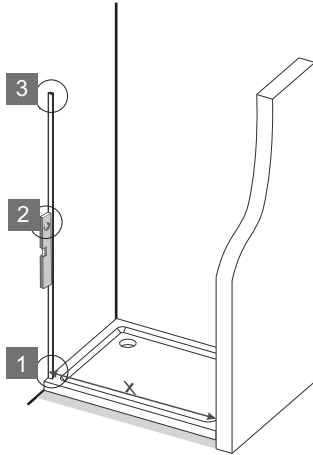
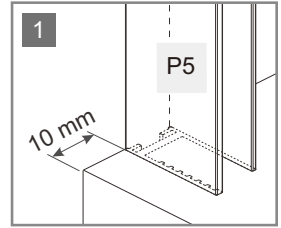

P5



x1



### 3.

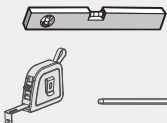
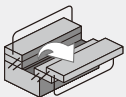
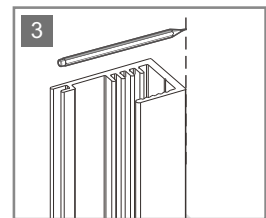
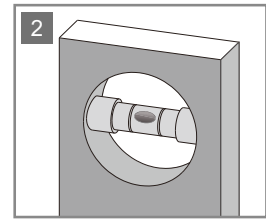
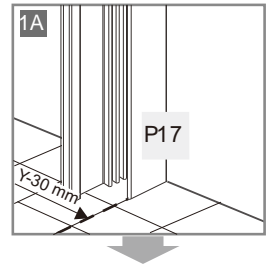
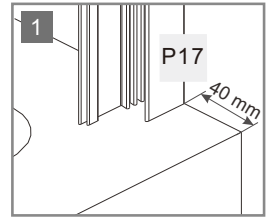
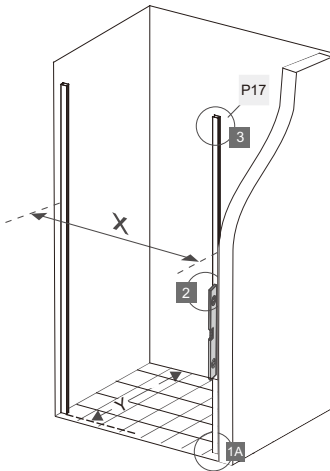
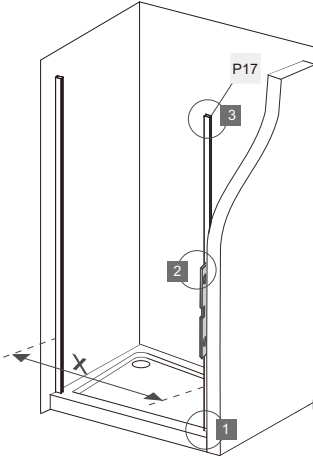
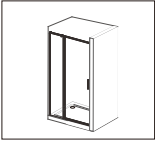

P17 ————— x1



4.

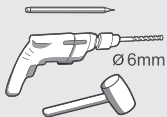
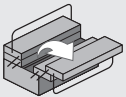
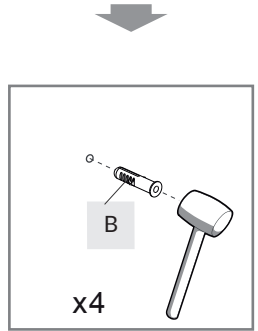
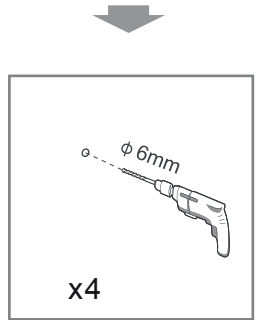
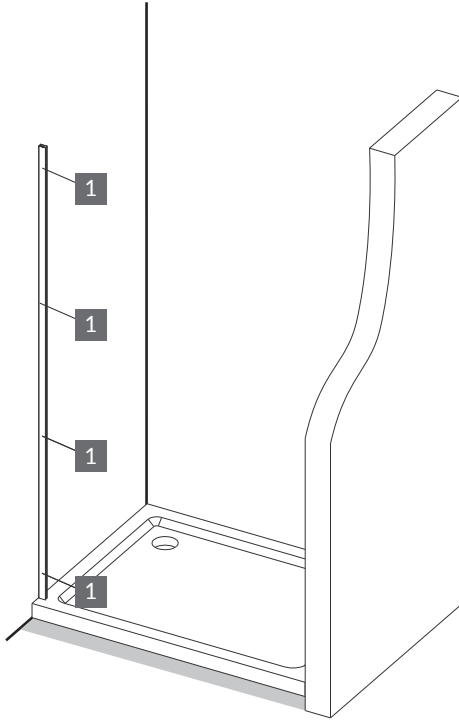
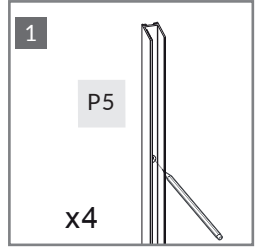
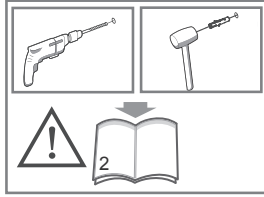
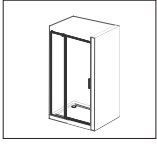

B



x4





# 5.

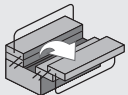
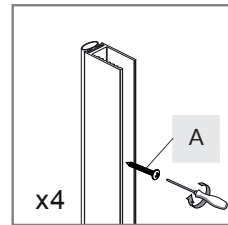
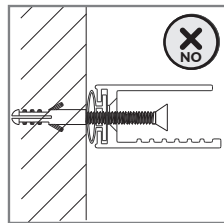
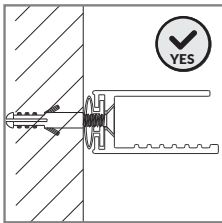
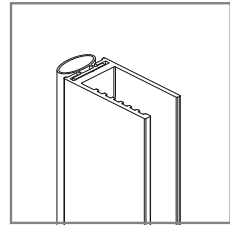
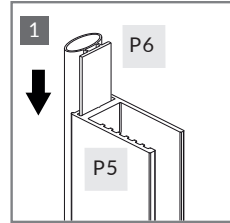
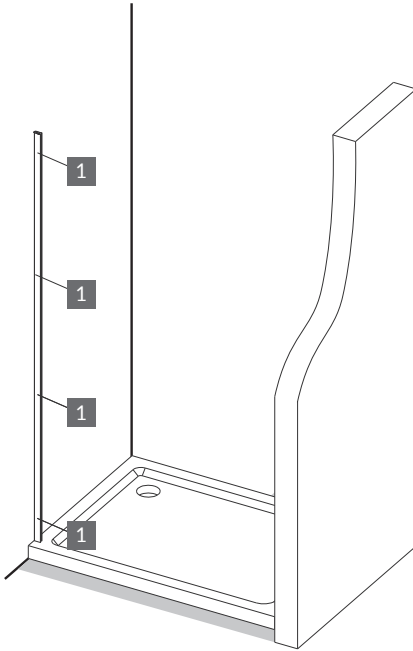
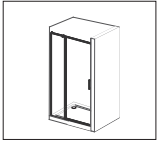

A

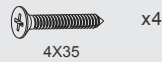

x4

P5

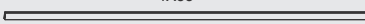

P6



6.

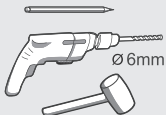
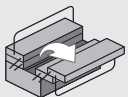
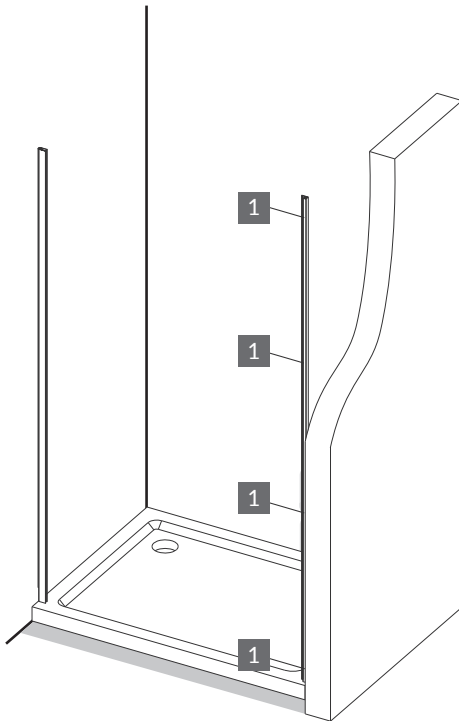
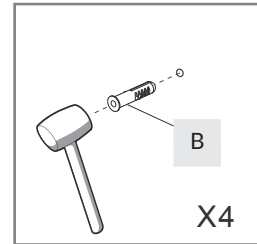
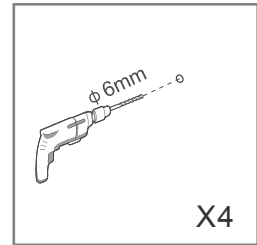
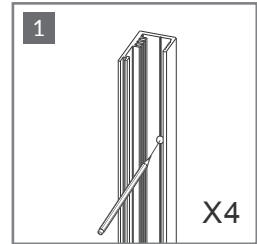
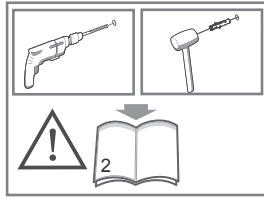
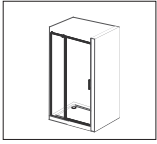

B



x4



7.

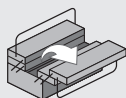
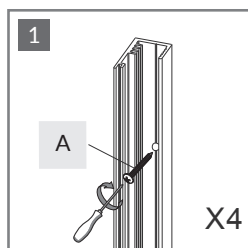
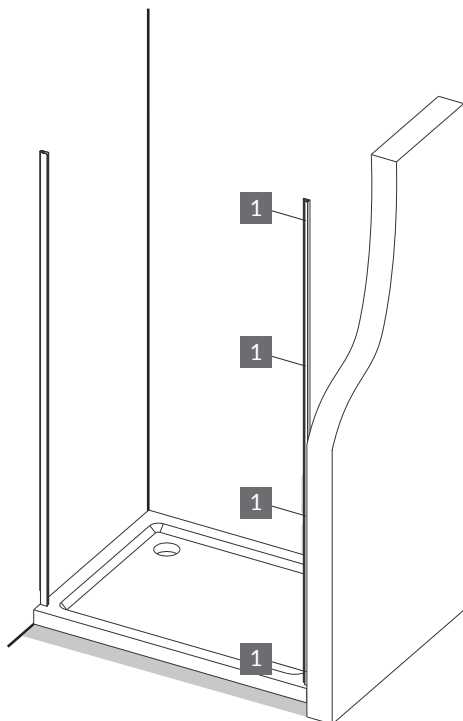

A



x4



8.

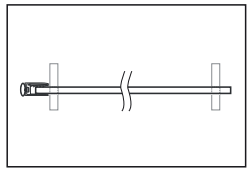
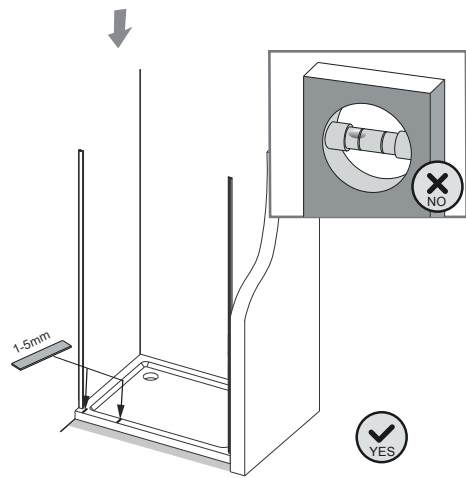
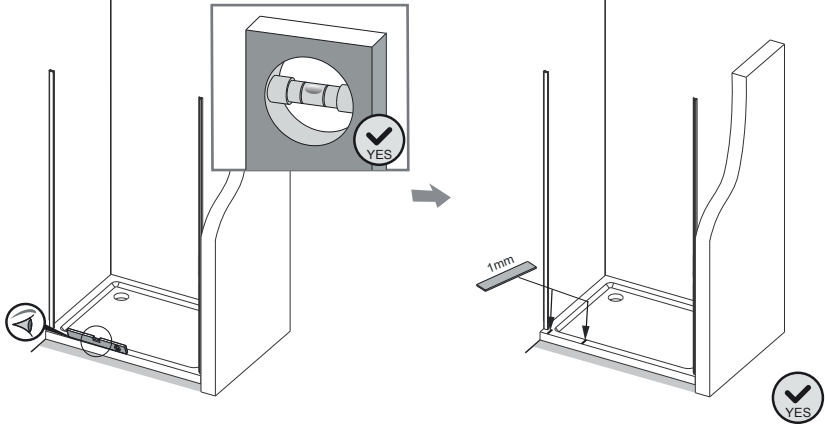
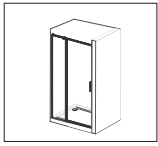

# 9.

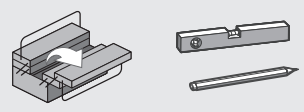
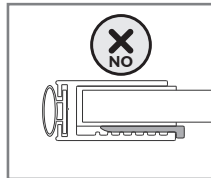
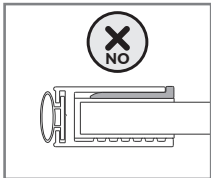
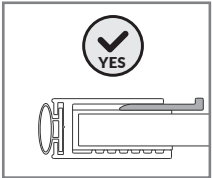
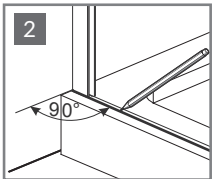
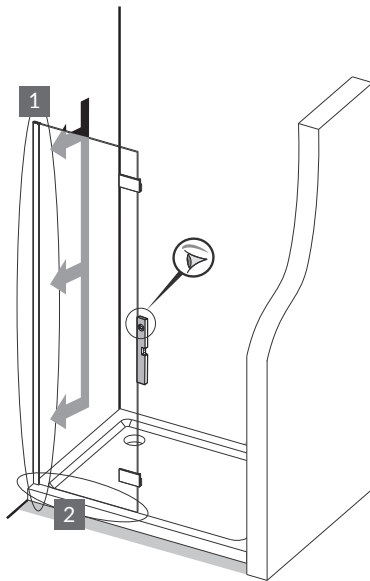
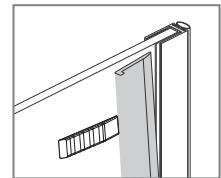
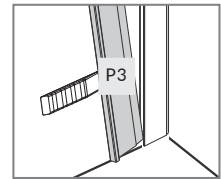
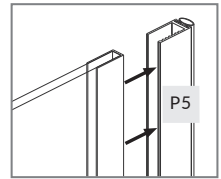
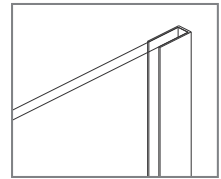
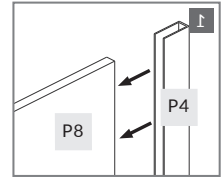
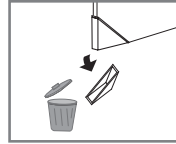
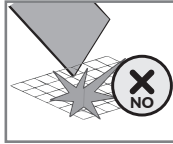
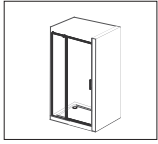

- P4 x1
- P3 x1
- M x1



# 10.

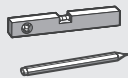
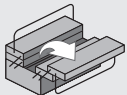
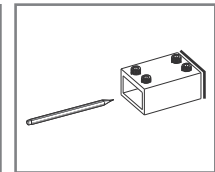
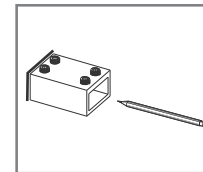
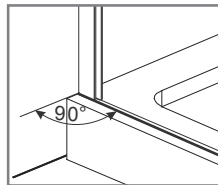
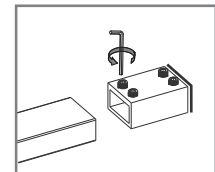
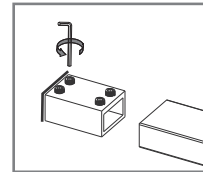
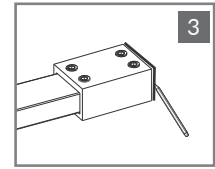
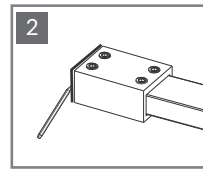
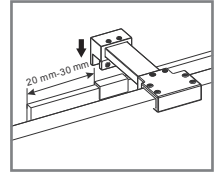
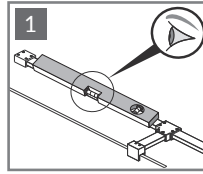
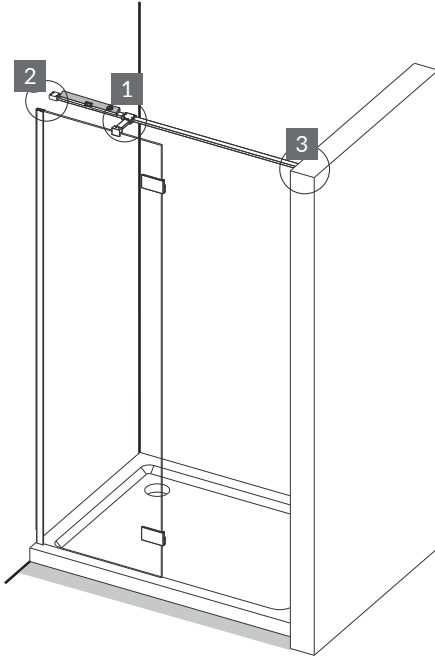
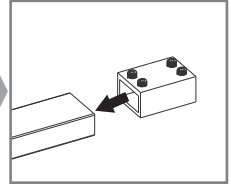
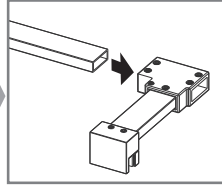
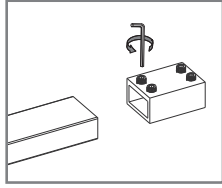
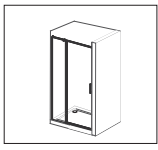

P9

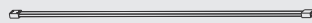

x1

P10



x4



x4

x1



# 11.

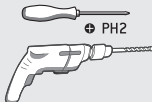
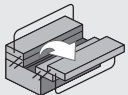
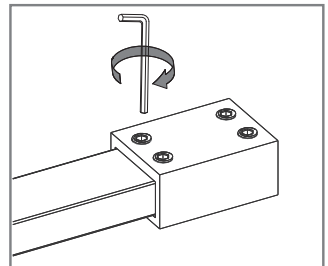
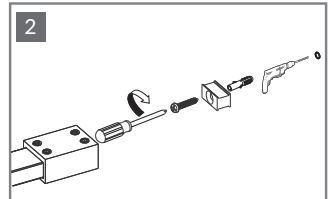
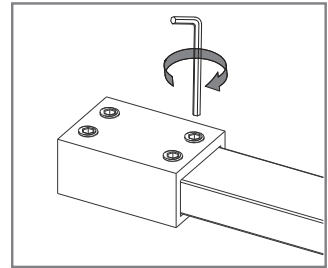
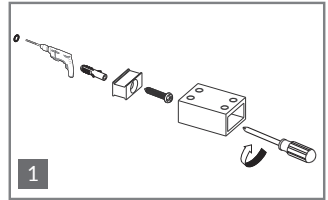
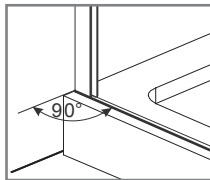
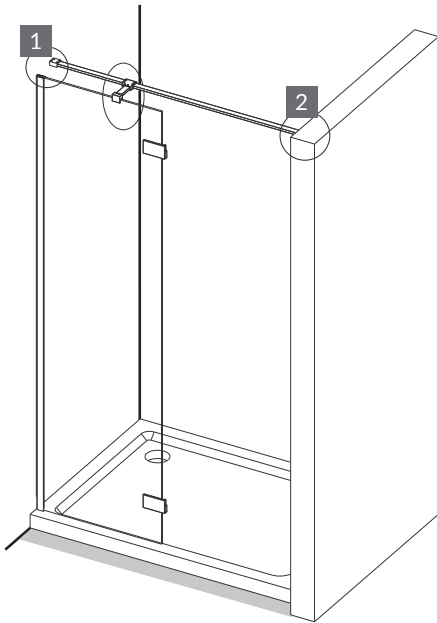
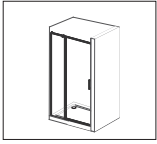

P9

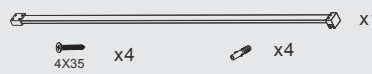

12.

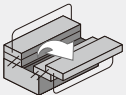
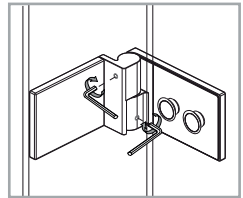
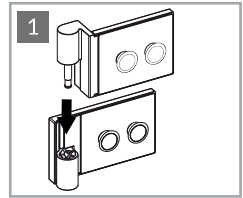
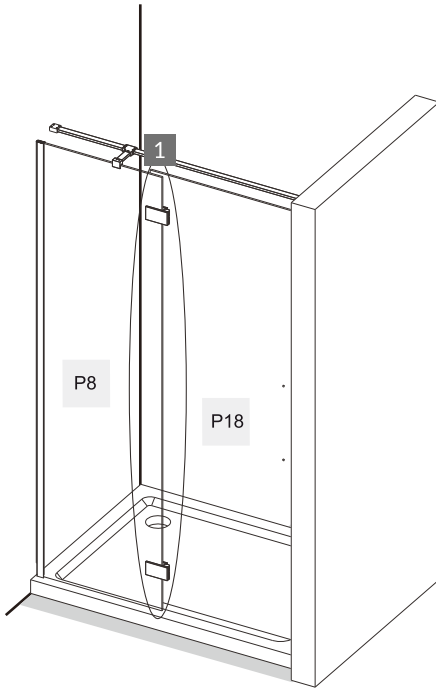
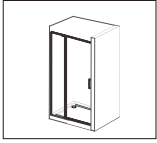







N  x1

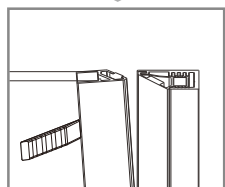
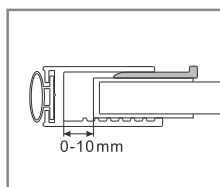
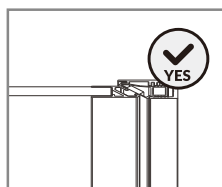
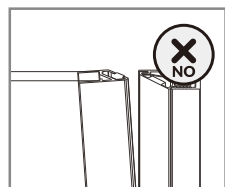
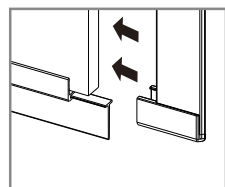
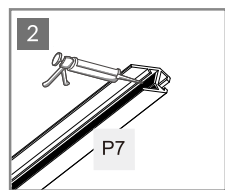
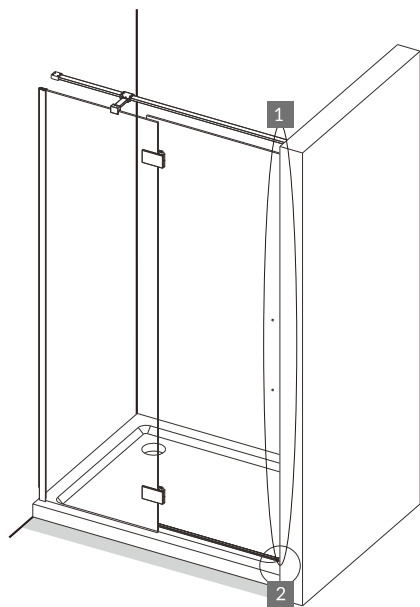
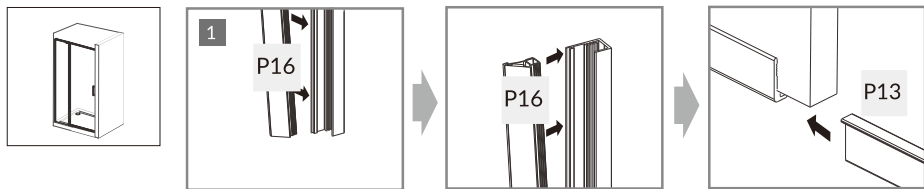

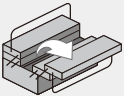
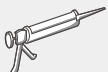

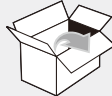
# 13.



|  |   |     |   |    |  |
|--|---|-----|---|----|--|
|  |  | P7  |  | x1 |  |
|  |   | P13 |  | x1 |  |
|  |   | P16 |  | x1 |  |
|  |   | M   |  | x1 |  |

14.

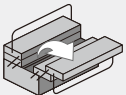
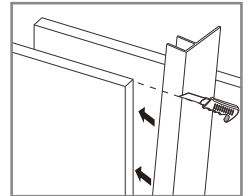
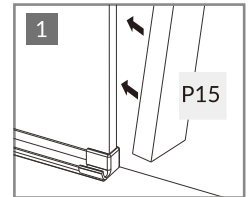
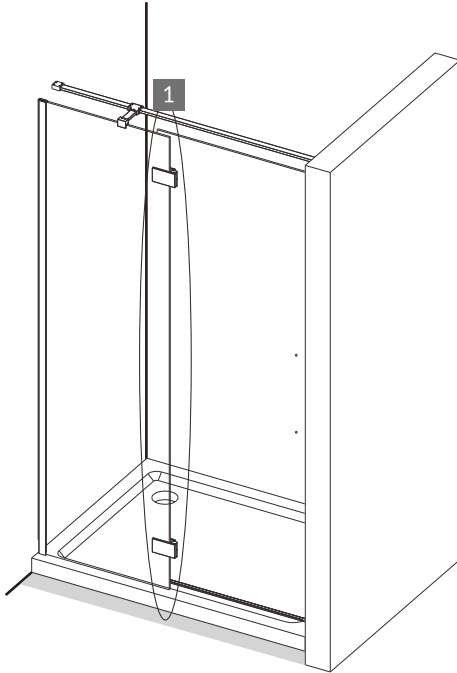

P15

x1



# 15.

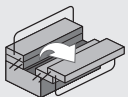
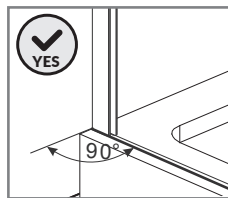
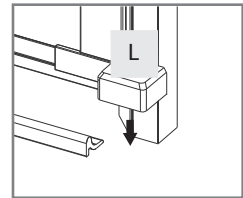
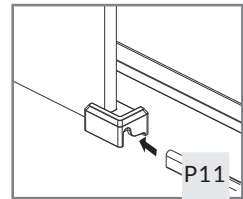
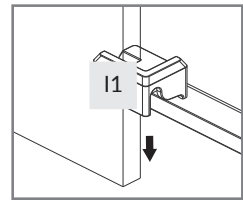
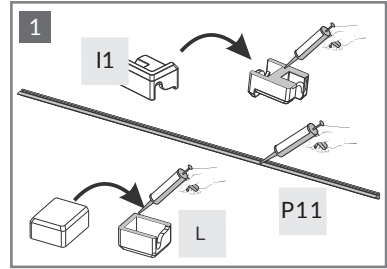
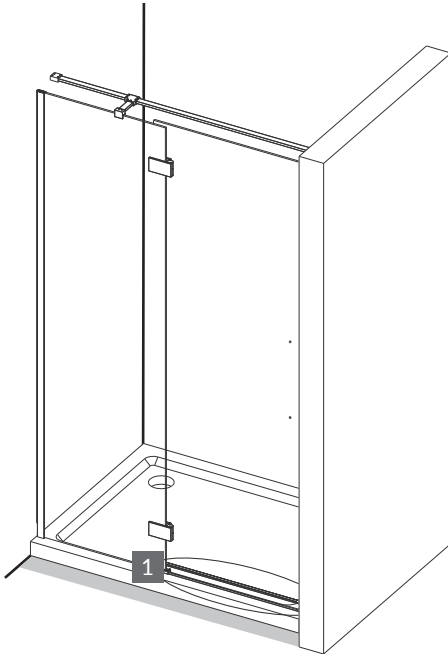
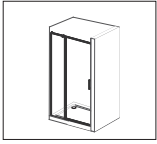

I1



x1

L



x1

P11



x1



16.

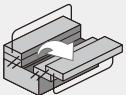
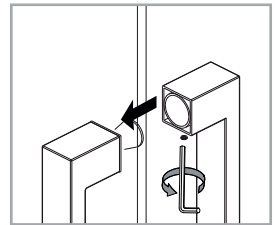
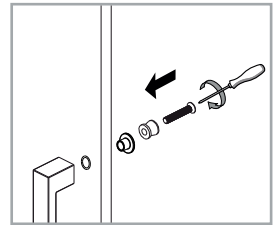
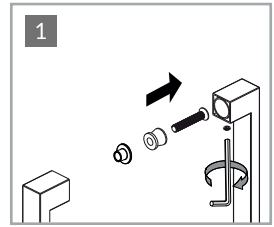
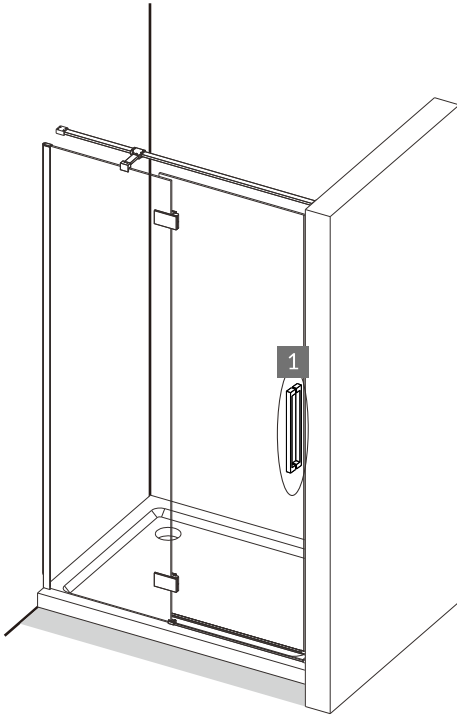
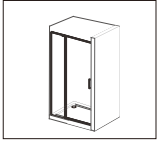

P14



x1



17.

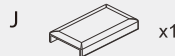
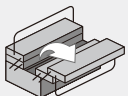
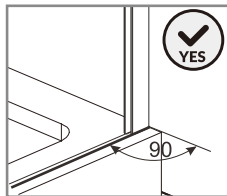
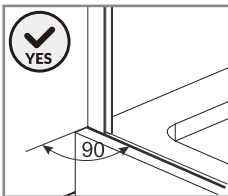
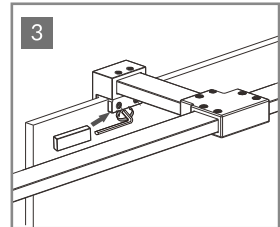
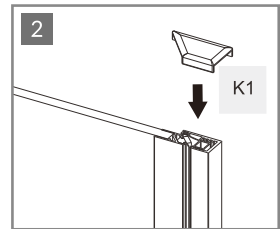
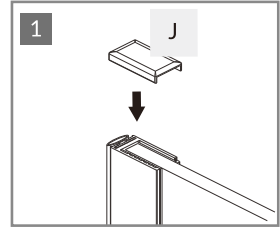
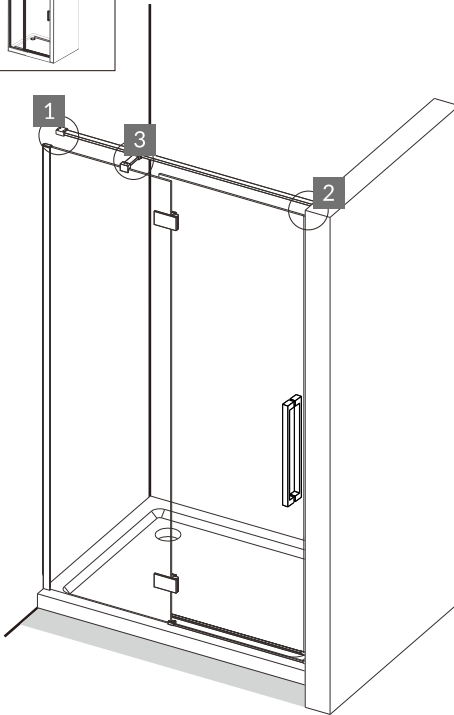
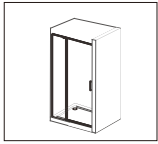

18.

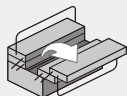
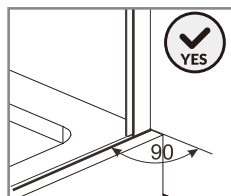
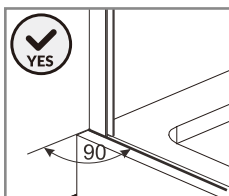
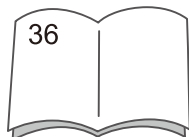
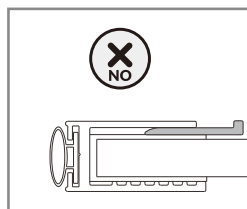
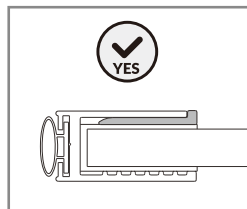
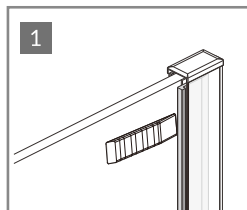
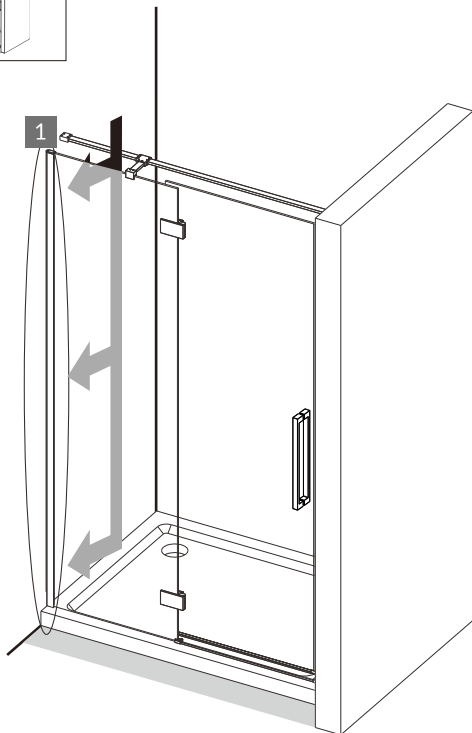
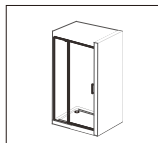

M



x1



# 19.



| SIZE        | X(mm)     |
|-------------|-----------|
| 900 × 2000  | 890-900   |
| 1000 × 2000 | 990-1000  |
| 1200 × 2000 | 1190-1200 |

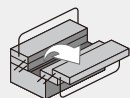
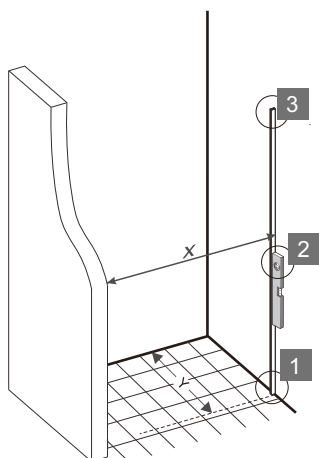
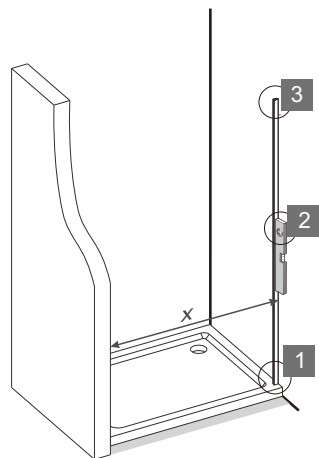
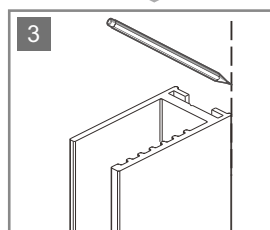
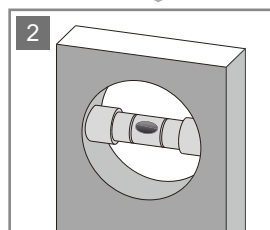
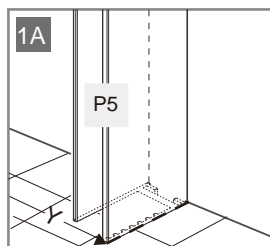
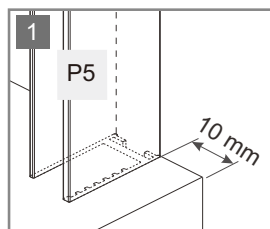

P5

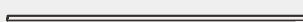

x1



20.

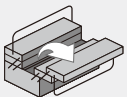
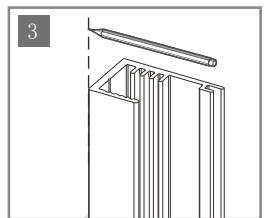
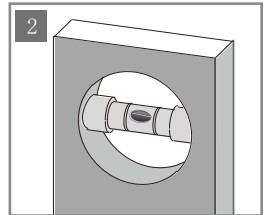
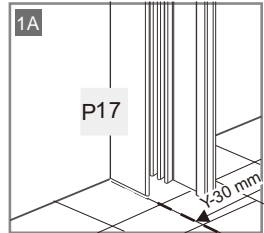
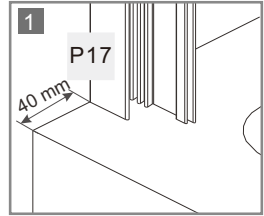
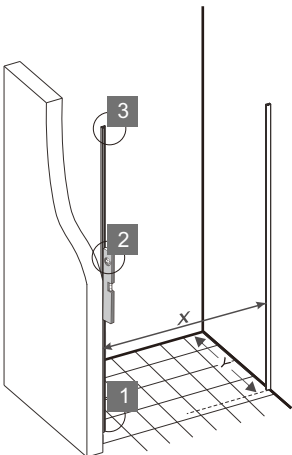
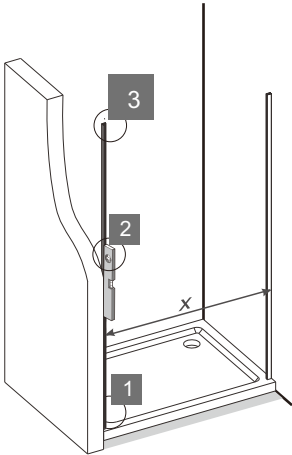
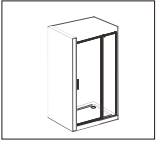

P17

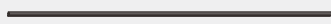

x1





21.

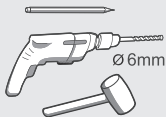
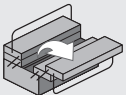
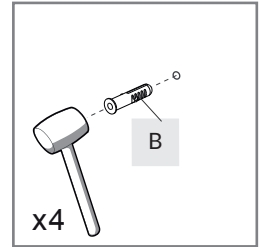
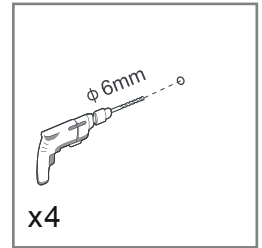
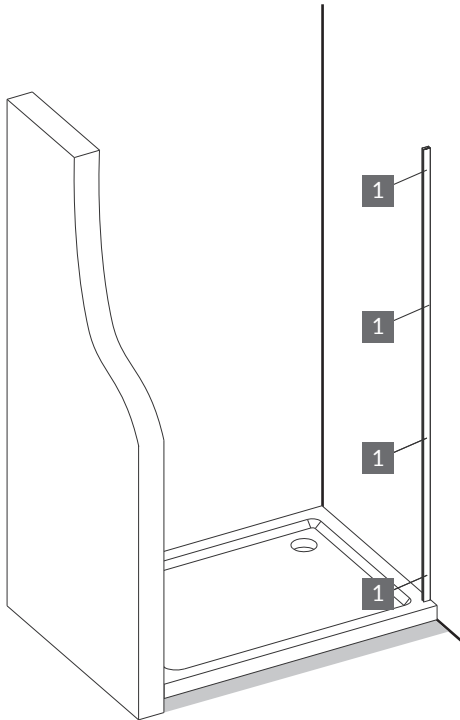
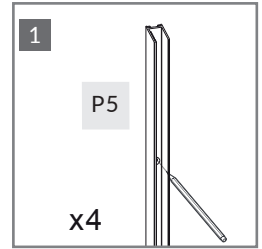
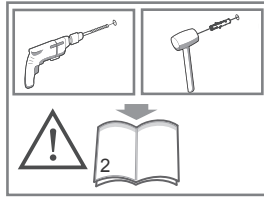
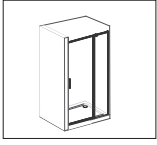

B



x4



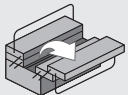
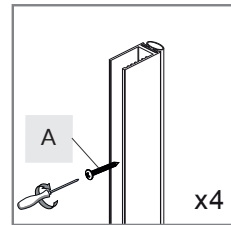
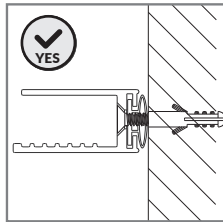
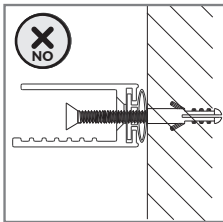
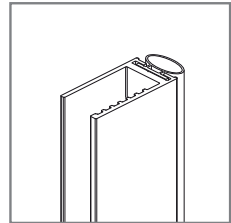
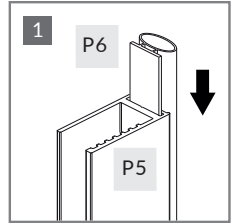
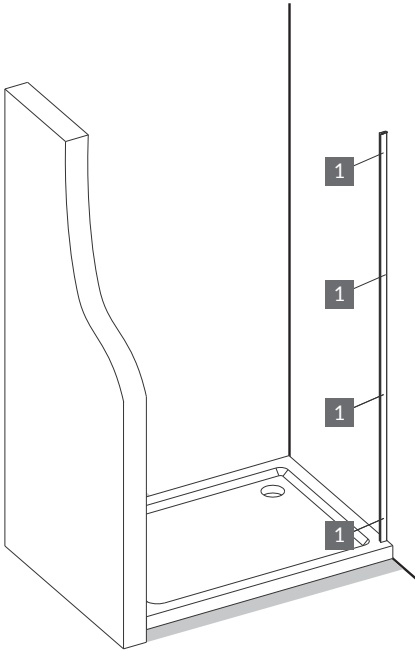
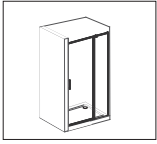

A

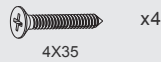

x4

P5

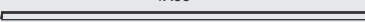

P6



23.

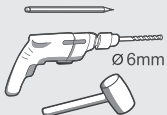
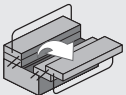
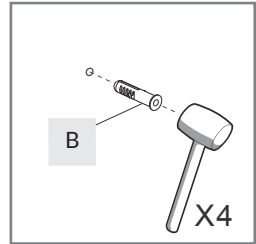
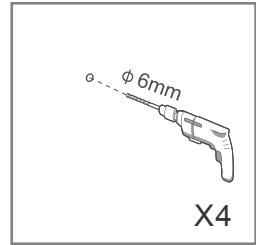
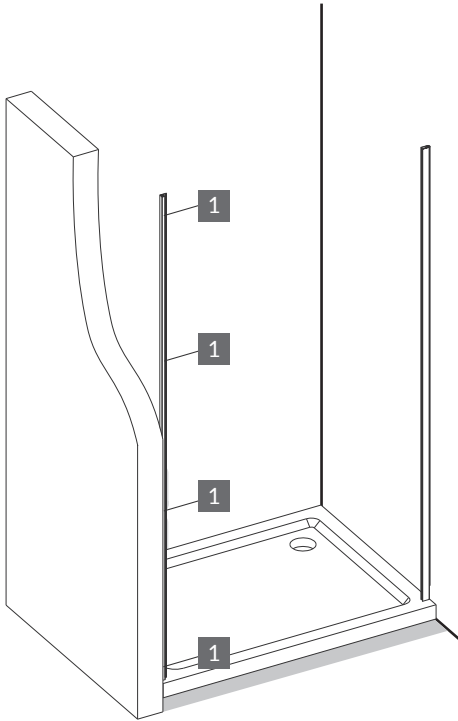
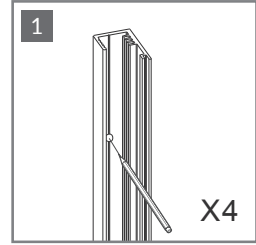
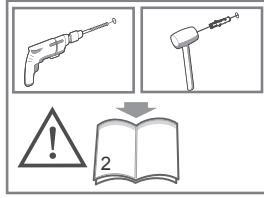
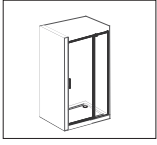

B



x4



24.

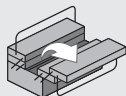
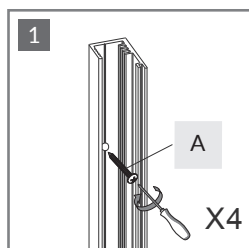
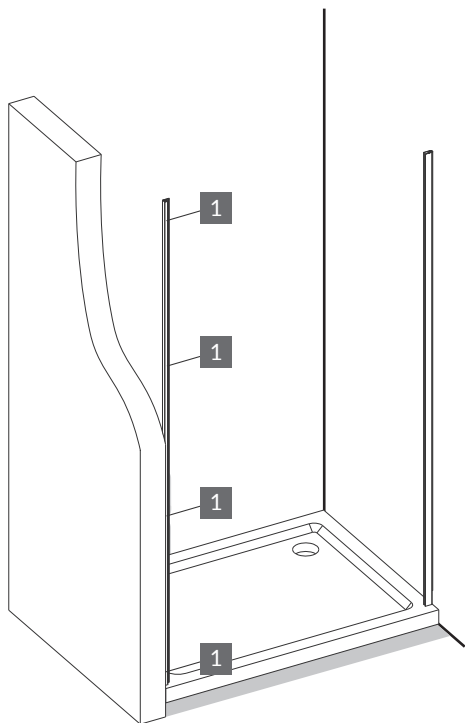

A



x4



25.

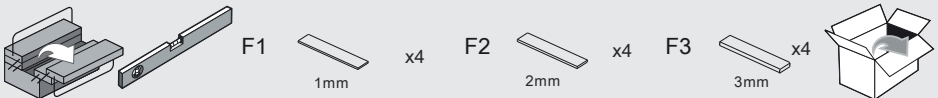
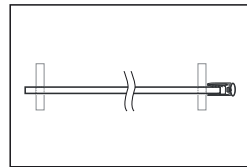
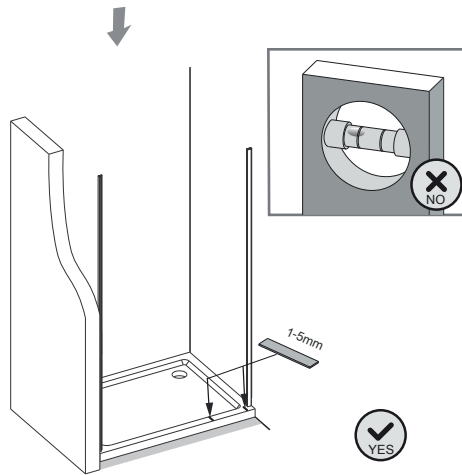
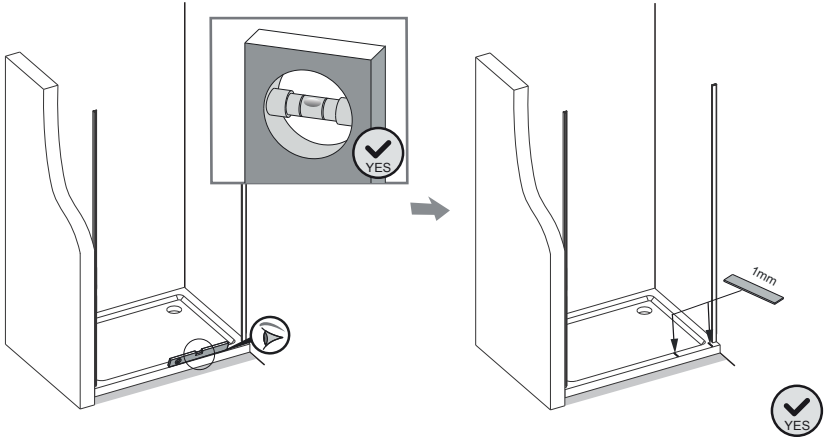
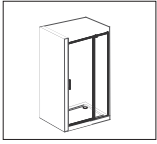

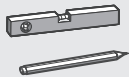
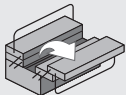
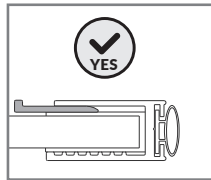
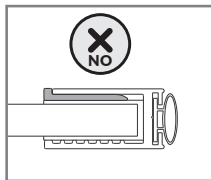
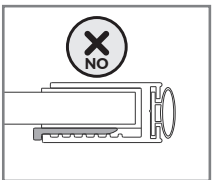
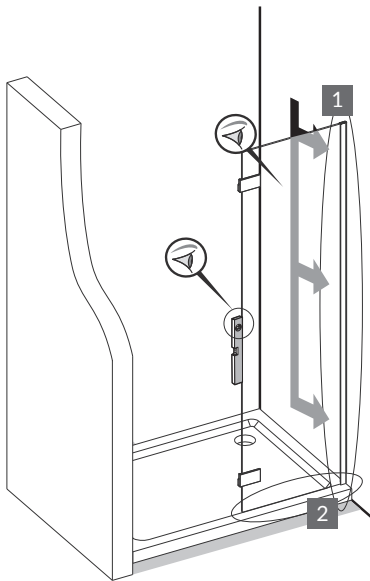
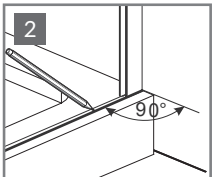
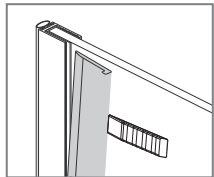
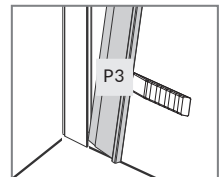
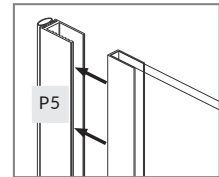
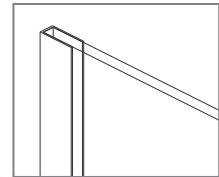
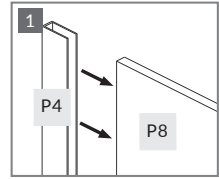
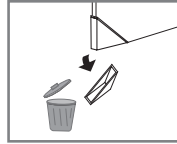
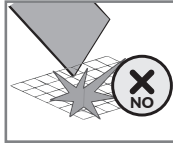
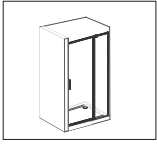

P4 ————— x1

P3 ————— x1

M ————— x1



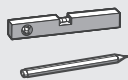
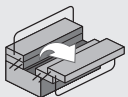
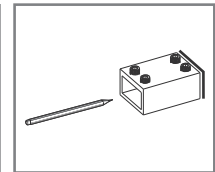
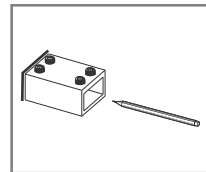
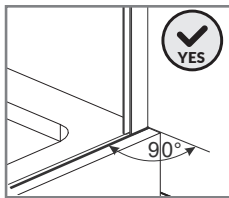
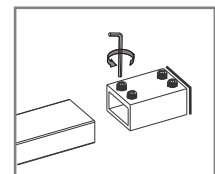
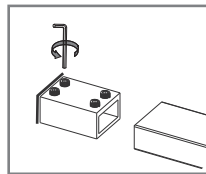
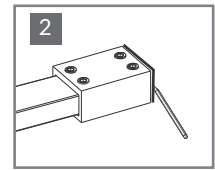
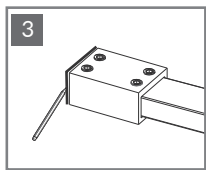
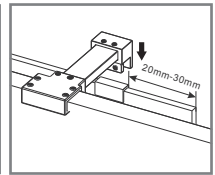
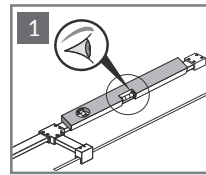
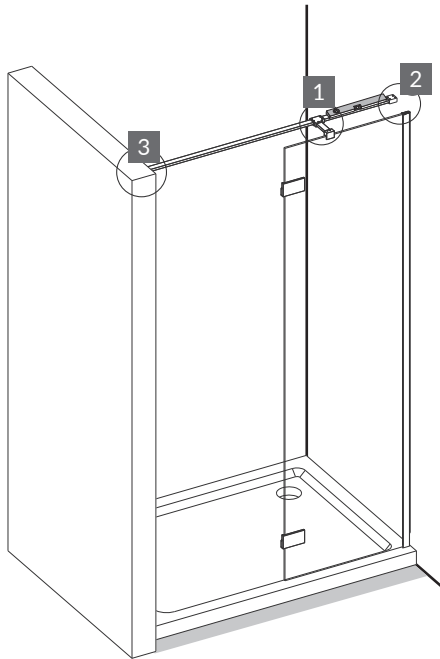
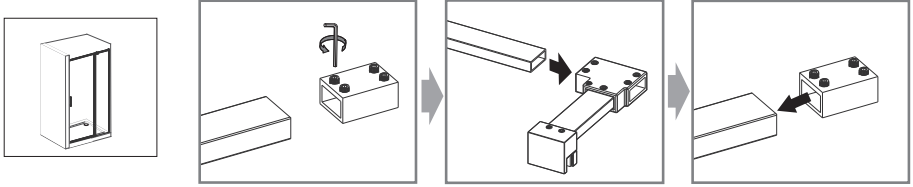

P9

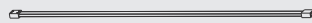

x1

P10

4X35 x4



x4

x1



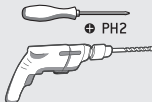
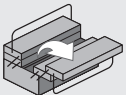
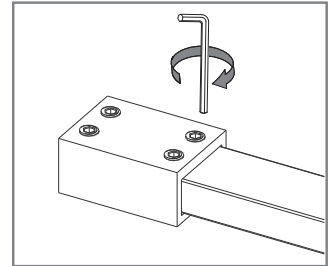
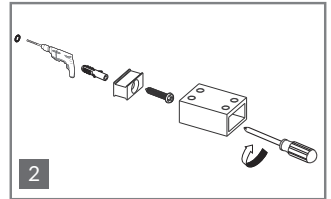
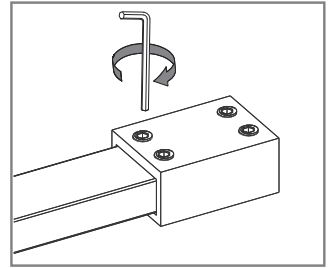
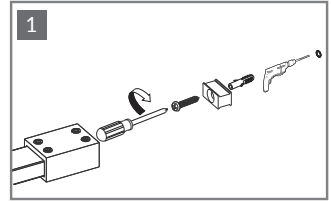
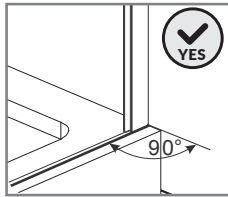
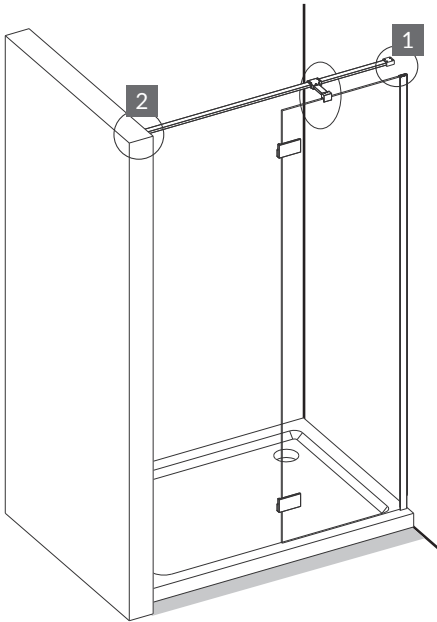
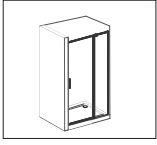

P9

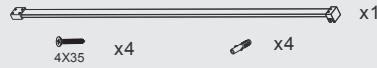

4X35 x4

x4





29.

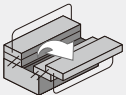
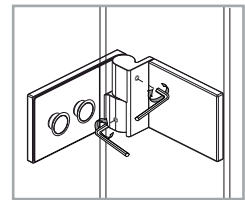
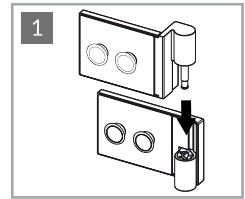
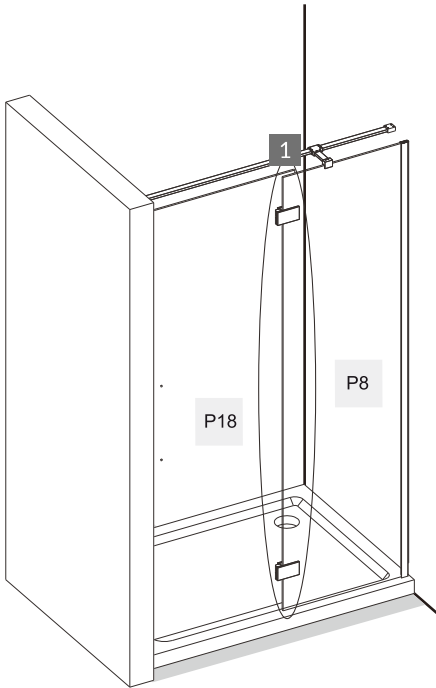
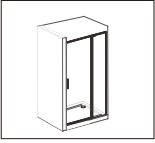

N



x1



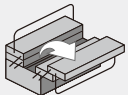
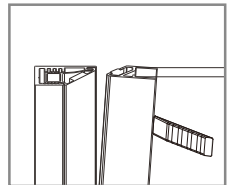
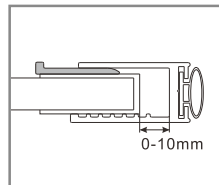
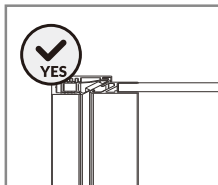
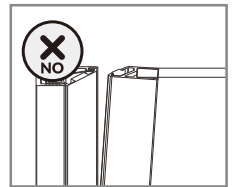
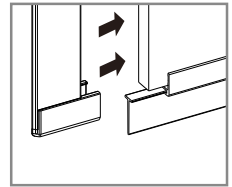
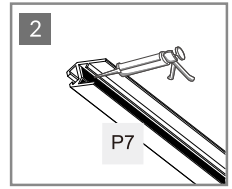
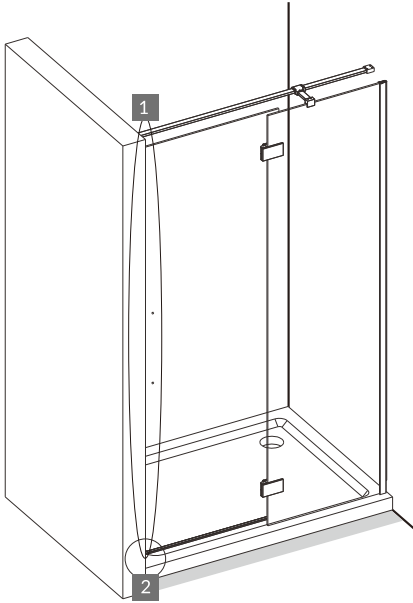
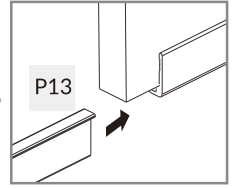
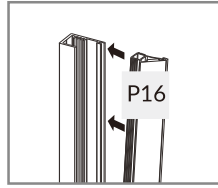
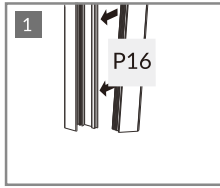
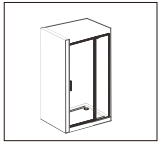

- P7 ————— x1
- P13 ————— x1
- P16 ————— x1
- M ————— x1



31.

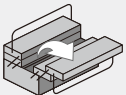
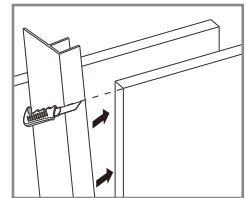
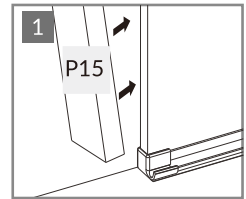
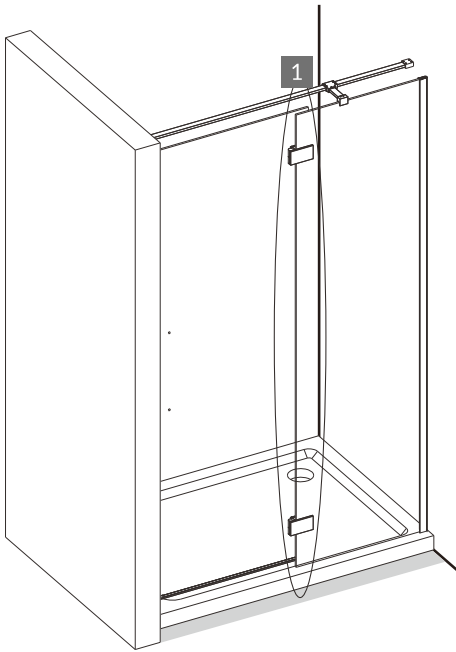
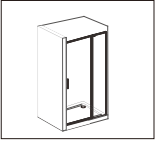

P15 ————— x1



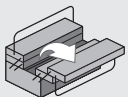
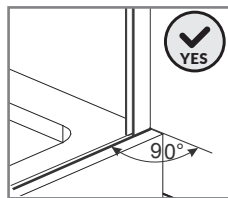
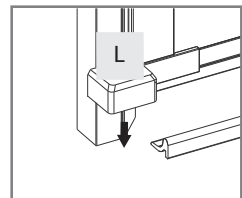
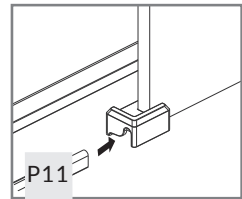
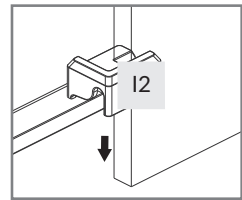
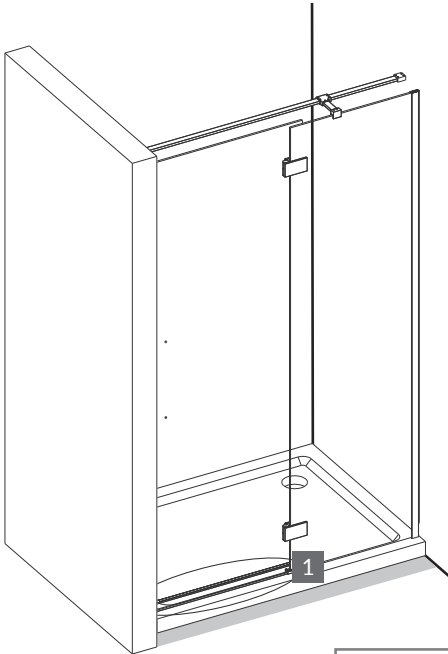
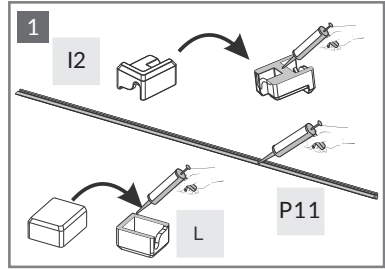
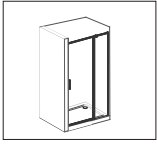

I2



x1

L



x1

P11



x1



33.

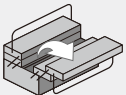
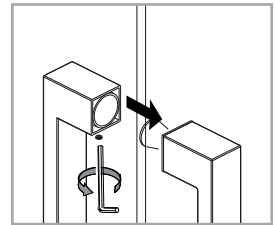
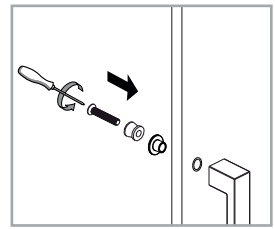
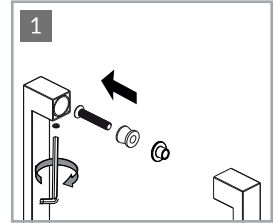
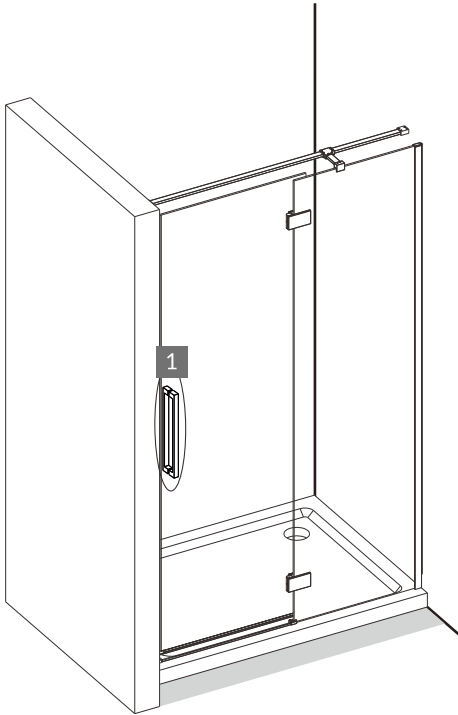
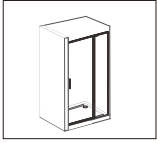

P14



x1



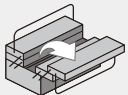
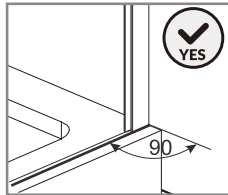
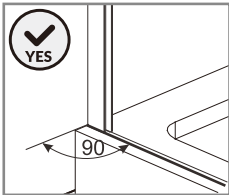
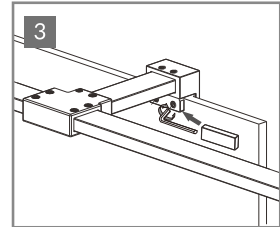
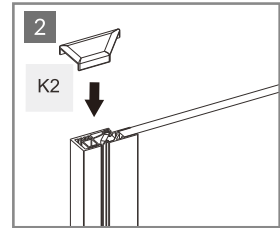
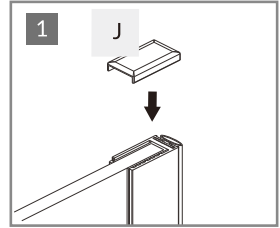
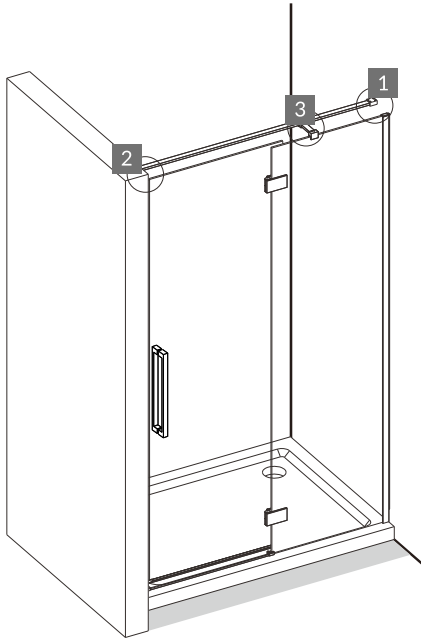
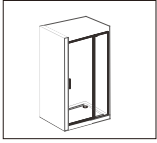

35.

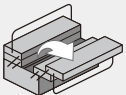
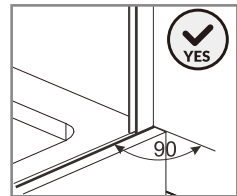
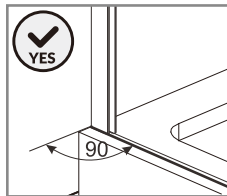
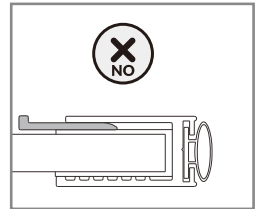
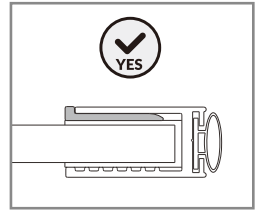
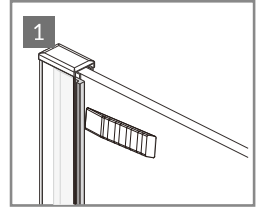
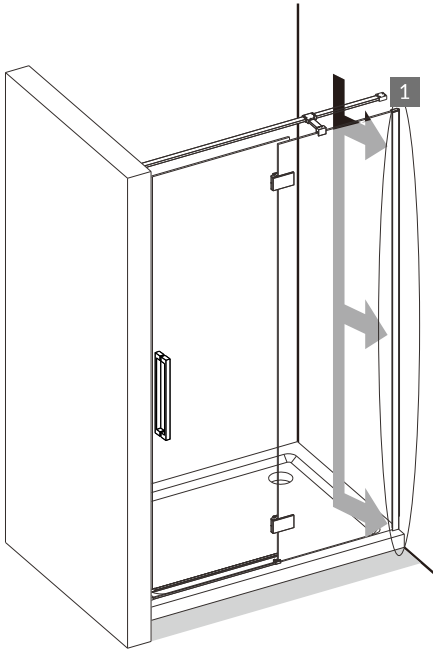
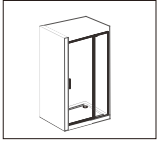

M



x1



36.

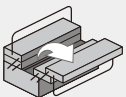
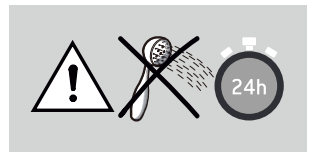
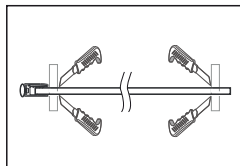
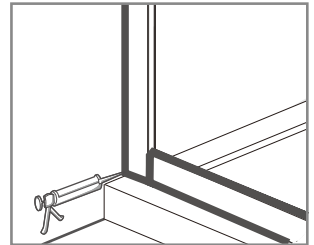
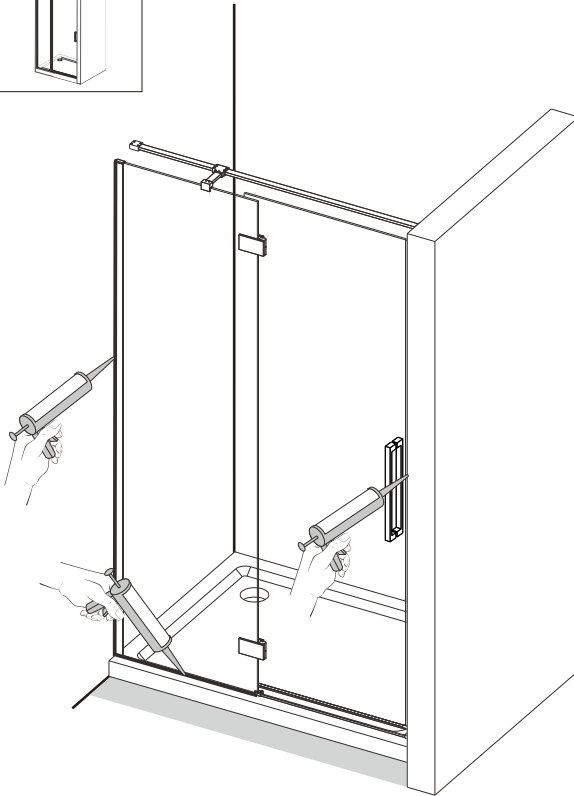
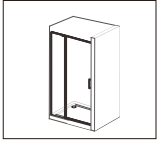





6.5 < PH < 7.5

